

**HOSE, CORD & CABLE REELS**

# **ELECTRICAL**

**COXREELS SINCE 1923**



**PRODUCT CATALOG**

# ELECTRICAL REELS



**IT'S NOT JUST A LABEL,  
IT'S A BADGE OF HONOR**

Hose, cord and grounding cable reels are essential equipment in the aviation industry and specifically in the aircraft maintenance and ground support segments. Reels are the preferred choice for managing hoses or neatly and conveniently storing them.

## ***The Recognized Industry Leader***

Coxreels is wholesale only since 1923. Our product is made to high standards, supplying industrial grade product to distributors and OEMs worldwide. We are recognized as the leader in the reeling industry. We have been providing the most complete and diverse line of hose, cord, and cable reels for 10 decades!

## ***The Most Complete Line of Electric Reels in the Market***

Electrical cord reels are an essential component for delivering industrial-grade power sources where you need it, without the fuss of tangled extension cords getting in the way, taking up precious room and time. Add efficiency to your worksite, all while increasing safety by reducing trip hazards of excess cord out, with our durable and reliable power cord (PC) reels, which supply steady power to your tools and machinery. Choose from a variety of accessories to attach on the business-end of our power reels. With a variety of light options to choose from, you'll never be left in the dark again when the job needs to get done. Coxreels® has remained steadfast and focused on manufacturing high quality, industrial grade cord reels, and our electrical reels are no exception.

## ***Proven reeling solutions to electrical needs!***

Coxreels® has the broadest, most complete line of reels, perfectly suited to help you get the job done – efficiently and effectively. We got you covered!

- Electrical Contractors
- Workstations / Work Benches
- Service / Utility Trucks
- Power Tools
- Battery Charging
- Airports
- Municipalities / Railroads / DOT
- Portable Light Source
- Service Garages
- Construction Sites
- Manufacturing Plants
- Fire Stations / Police Stations
- Power Plants / Solar / Hydroelectric
- Security

Our versatile and wide reel selection handles various capacities and comes in different sizes to suit any construction requirement. Our standard reeling devices suggested in this catalog are already specified to meet the needs of the electrical markets. Coxreels also has the engineering power to design and build custom reels, so please consult the factory if you cannot locate a reel that will work with your equipment, we will be happy to assist you with a solution.

***VALUE THE DIFFERENCE...***

***Make COXREELS your reel choice!***



# PROFESSIONAL GRADE FEATURES

## A HIGHER LEVEL OF STANDARDS



**CPC™ POWDER COAT**  
Our blue powder coat finish is long lasting, chip resistant & rust inhibiting



**BRASS SWIVEL**  
External fluid path, machined from solid brass, full flow, swivel for simple seal maintenance



**STEEL AXLE**  
1" solid steel axle & lubricated bearings for extra strength & durability. Not a hollow tube & no fluid travels through it

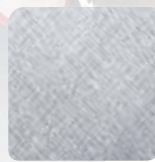

**STEEL CONSTRUCTION**  
High-Quality steel construction provides superior strength and durability for heavy-duty applications in commercial and industrial settings



**COMPONENT COVER**  
External CPC powder coated steel components cover for simple slip ring routine maintenance



**EZ-COIL® SERIES**  
A patented safety system that retracts up to 80% slower than conventional reels



**CNC SPUN DISCS**  
All steel rolled edges & ribbed discs for added safety, strength & durability



**CARTRIDGE MOTOR**  
Enclosed factory tuned & matched cartridge style motor for safe & easy replacement

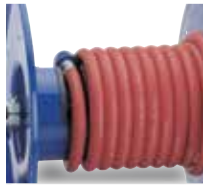

**LOW PROFILE RISER**  
Low profile riser with open drum slot allows for smooth even hose wraps that will not pinch or bind your hose. **NO HUMP!**



**ALL WELDED STEEL "A" FRAME**  
All welded steel "A" frame for strength & durability. **NOT BOLTED!**



**2 YEAR WARRANTY**  
Coxreels proudly stands behind our reels as they are built to last!



**USA MADE, QUALITY & SUPPORT**  
We take great pride in designing, building & supplying the world's finest reels made right here in the U.S.A.

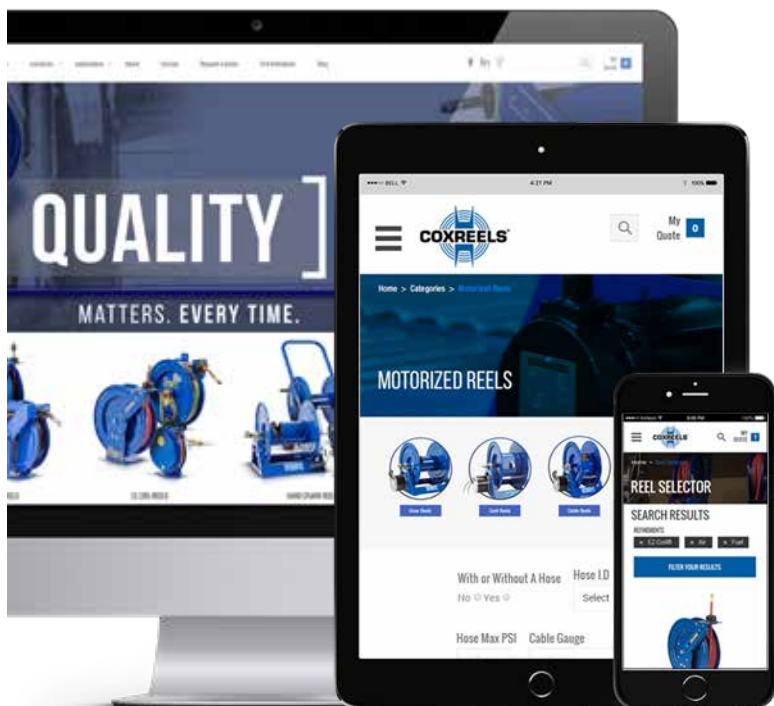

## VISIT US ONLINE

Coxreels is committed to providing our customers with the ultimate online experience as they navigate through the most complete and diverse line of hose, cord, and cable reels.

We hope that you enjoy the fresh look and feel of our updated website and find that this portal serves as a valuable resource for you!

FOLLOW US



[www.coxreels.com](http://www.coxreels.com) • 1.800.COX.REEL





ELECTRICAL

# PC<sup>10</sup> SERIES

## COMPACT POWER CORD REELS

**COXREELS® PC<sup>10</sup> Series Power-Cord Series** is a unique compact addition to our original line of power cord and light reels. This ground-breaking design sets a new bar as the ideal cord management solution capable of fulfilling any commercial or industrial application where space is limited. Modeled after the LG "Little Giant" Series, this Series is equipped with a continuous radius grommet style power cord guide and a unique C-PEP™ Composite hub featuring excellent chemical resistance and additional strength at cold temperatures.

### PC<sup>10</sup> SERIES

MODEL	ACCESSORY	CORD						SIZE INDEX
		AWG / NO COND.	CORD FT.	TYPE	VOLTS	AMPS	APRX. LBS.	
<b>FOR INDOOR USE ONLY!</b> All models rated at 115 volts, 60 hz single phase only.								
PC10-3016-A	Single Industrial Receptacle† 	16 / 3	30	SJO	115	13	14	1
PC10-3012-A		12 / 3	30	SJO	115	20	17	1
PC10-3012-B	Quad "4 Plug" Industrial Receptacle† 	12 / 3	30	SJO	115	20	18	1
PC10-3016-F	Duplex G.F.C.I. Metal Industrial Receptacle† 	16 / 3	30	SJO	115	13	16	1
PC10-3012-F		12 / 3	30	SJO	115	20	19	1
PC10-3016-X	With Cord, Less Accessory	16 / 3	30	SJO	300	13	14	1
PC10-3012-X		12 / 3	30	SJO	300	20	18	1
PC10L-3016	Less Cord, Less Accessory	16 / 3	30*	SJO	300	13	11	1
PC10L-3012		12 / 3	30*	SJO	300	20	11	1

\*Consult factory with 4 conductor requirements.

### PC<sup>10</sup> SERIES :: REEL SPECIFICATIONS

 Listed† :: Accessories only

#### SLIP RING

- External heavy gauge CPC™ powder coated steel components cover for simple slip ring routine maintenance
- Electrical current runs through a 25AMP / 600V rated slip ring
- Include 5' lead cable & grounding plug (except on less cord models)

#### DESIGN & STRUCTURE

- Compact & lightweight spring driven cord reel save space & facilitate workplace organization
- CoxComposite™ grommet with continuous radius design that does not pinch or catch the cord during operation
- Solid one piece, 12GA steel base & support post for maximum stability
- ½" solid steel axle & lubricated precision bearings for smooth rotation
- Enclosed factory tuned & matched cartridge-style spring motor
- Non-corrosive CoxComposite™ ratchet hub with self lubricating bronze bearings secures cord at desired length
- See page 14 for electrical accessories

### REEL DIMENSIONS

Technical Data Sheets Available On Website

SIZE INDEX	W	H	L	X	Y	M	N
1	7¾"	10⅝"	10½"	4⅝"	8⅜"	2½"	6"
	Overall Dimensions			Base		Mounting Pattern	

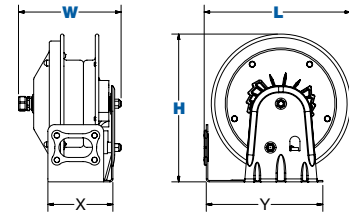

SPRING DRIVEN

### TOP REQUESTED UPGRADES & ACCESSORIES

SEE PAGE 10 FOR ADDITIONAL ACCESSORIES



#### UPGRADE YOUR LEAD CABLE

Upgrade the reach of your reel by requesting a 10' lead cable instead of the standard 5'.





WARNING: Cancer and reproductive Harm – See page 11 for more information – [www.P65Warning.ca.gov](http://www.P65Warning.ca.gov)





## PC<sup>10</sup> SERIES

CORD								SIZE INDEX
MODEL	ACCESSORY	AWG / NO COND.	CORD FT.	TYPE	VOLTS	AMPS	APRX. LBS.	
<b>FOR INDOOR USE ONLY!</b> All models rated at 115 volts, 60 hz single phase only.								
<b>PC10-3016-C</b>	Fluorescent Tube Light - Shock Absorbing & Shatter Resistant† 	16 / 3	30	SJTO	115	0.3	15	<b>1</b>
<b>PC10-3016-D</b>	Fluorescent Angle Light with Tool Tap Plug† 	16 / 3	30	SJTO	115	13	16	<b>1</b>
<b>PC10-3016-E</b>	Incandescent Caged Drop Light with Tool Tap Plug† 	16 / 3	30	SJTO	115	13	14	<b>1</b>

\*Consult factory with 4 conductor requirements.



Listed† :: Accessories only

### PC<sup>10</sup> SERIES :: REEL SPECIFICATIONS

#### SLIP RING

- External heavy gauge CPC™ powder coated steel components cover for simple slip ring routine maintenance
- Electrical current runs through a 25AMP / 600V rated slip ring
- Include 5' lead cable & grounding plug (except on less cord models)

#### DESIGN & STRUCTURE

- Compact & lightweight spring driven cord reel save space & facilitate workplace organization
- CoxComposite™ grommet with continuous radius design that does not pinch or catch the cord during operation
- Solid one piece, 12GA steel base & support post for maximum stability
- ½" solid steel axle & lubricated precision bearings for smooth rotation
- Enclosed factory tuned & matched cartridge-style spring motor
- Non-corrosive CoxComposite™ ratchet hub with self lubricating bronze bearings secures cord at desired length
- See page 14 for electrical accessories

SPRING DRIVEN

### REEL DIMENSIONS

Technical Data Sheets Available On Website

SIZE INDEX	W	H	L	X	Y	M	N
<b>1</b>	7 <sup>3</sup> / <sub>8</sub> "	10 <sup>5</sup> / <sub>8</sub> "	10 <sup>1</sup> / <sub>2</sub> "	4 <sup>5</sup> / <sub>8</sub> "	8 <sup>3</sup> / <sub>8</sub> "	2 <sup>1</sup> / <sub>2</sub> "	6"
	Overall Dimensions			Base		Mounting Pattern	

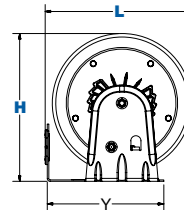
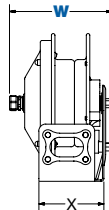

## TOP REQUESTED UPGRADES & ACCESSORIES

SEE PAGE 10 FOR ADDITIONAL ACCESSORIES



### UPGRADE YOUR LEAD CABLE

Upgrade the reach of your reel by requesting a 10' lead cable instead of the standard 5'.



WARNING: Cancer and reproductive Harm – See page 11 for more information – www.P65Warning.ca.gov



# PC SERIES

## POWER CORD REELS



**COXREELS® PC Series** spring driven "Power Cord" reels are heavy duty, industrial grade power sources. They replace tangled extension cords and self-retract to increase safety, productivity and efficiency. Modeled after the P and SH Series, the PC Series are designed for long-lasting, trouble-free performance even under the most demanding conditions.

### PC SERIES

		CORD							EZ-COIL MODELS	SIZE INDEX
MODEL	ACCESSORY	AWG / NO COND.	CORD FT.	TYPE	VOLTS	AMPS	APRX. LBS.			
<b>FOR INDOOR USE ONLY!</b>		All models rated at 115 volts, 60 hz single phase only.								
<b>PC13-3516-A†</b>	Single Industrial Receptacle†	16 / 3	35	SJO	115	13	34	-	<b>1</b>	
<b>PC13-5016-A†</b>		16 / 3	50	SJO	115	13	36	<b>EZ-PC13-5016-A</b>	<b>1</b>	
<b>PC19-7516-A†</b>		16 / 3	75	SJO	115	13	60	-	<b>3</b>	
<b>PC24-0016-A†</b>		16 / 3	100	SJO	115	13	73	<b>EZ-PC24-0016-A</b>	<b>4</b>	
<b>PC13-3512-A†</b>	Quad "4 Plug" Industrial Receptacle†	12 / 3	35	SJO	115	20	37	-	<b>1</b>	
<b>PC13-5012-A†</b>		12 / 3	50	SJO	115	20	40	<b>EZ-PC13-5012-A</b>	<b>1</b>	
<b>PC19-7512-A†</b>		12 / 3	75	SJO	115	20	67	-	<b>3</b>	
<b>PC24-0012-A†</b>		12 / 3	100	SJO	115	20	81	<b>EZ-PC24-0012-A</b>	<b>4</b>	
<b>PC13-3512-B†</b>	Duplex G.F.C.I. Metal Industrial Receptacle†	12 / 3	35	SJO	115	20	38	-	<b>1</b>	
<b>PC13-5012-B†</b>		12 / 3	50	SJO	115	20	41	<b>EZ-PC13-5012-B</b>	<b>1</b>	
<b>PC19-7512-B†</b>		12 / 3	75	SJO	115	20	68	-	<b>3</b>	
<b>PC24-0012-B†</b>		12 / 3	100	SJO	115	20	84	<b>EZ-PC24-0012-B</b>	<b>4</b>	
<b>PC13-3516-F†</b>	Duplex G.F.C.I. Metal Industrial Receptacle†	16 / 3	35	SJO	115	13	36	-	<b>1</b>	
<b>PC13-5016-F†</b>		16 / 3	50	SJO	115	13	38	<b>EZ-PC13-5016-F</b>	<b>1</b>	
<b>PC19-7516-F†</b>		16 / 3	75	SJO	115	13	60	-	<b>3</b>	
<b>PC24-0016-F†</b>		16 / 3	100	SJO	115	13	73	<b>EZ-PC24-0016-F</b>	<b>4</b>	
<b>PC13-3512-F†</b>	Duplex G.F.C.I. Metal Industrial Receptacle†	12 / 3	35	SJO	115	20	39	-	<b>1</b>	
<b>PC13-5012-F†</b>		12 / 3	50	SJO	115	20	42	<b>EZ-PC13-5012-F</b>	<b>1</b>	
<b>PC19-7512-F†</b>		12 / 3	75	SJO	115	20	67	-	<b>3</b>	
<b>PC24-0012-F†</b>		12 / 3	100	SJO	115	20	83	<b>EZ-PC24-0012-F</b>	<b>4</b>	
<b>PC19-7516-X</b>	With Cord, Less Accessory	16 / 3	75**	SJO	115	13	60	-	<b>3</b>	
<b>PC24-0016-X</b>		16 / 3	100**	SJO	115	13	71	<b>EZ-PC24-0016-X</b>	<b>4</b>	
<b>PC13-5012-X††</b>		12 / 3	50**	SJO	115	20	40	<b>EZ-PC13-5012-X</b>	<b>1</b>	
<b>PC19-7512-X</b>		12 / 3	75**	SJO	115	20	66	-	<b>3</b>	
<b>PC24-0012-X</b>	With Cord, Less Accessory	12 / 3	100**	SJO	115	20	81	<b>EZ-PC24-0012-X</b>	<b>4</b>	
<b>PC17-3510-X††</b>		10 / 3	35**	SO	115	30	62	-	<b>2</b>	
<b>PC17-5010-X††</b>		10 / 3	50**	SO	115	30	67	-	<b>2</b>	
<b>PC13L-5016††</b>		Less Cord, Less Accessory	16 / 3	50*	SJO	115	25	31	<b>EZ-PC13L-5016</b>	<b>1</b>
<b>PC19L-7516</b>	16 / 3		75*	SJO	115	25	52	-	<b>3</b>	
<b>PC24L-0016</b>	16 / 3		100*	SJO	115	25	62	<b>EZ-PC24L-0016</b>	<b>4</b>	
<b>PC13L-5012††</b>	12 / 3		50*	SJO	115	25	29	<b>EZ-PC13L-5012</b>	<b>1</b>	
<b>PC19L-7512</b>	Less Cord, Less Accessory	12 / 3	75*	SJO	115	25	53	-	<b>3</b>	
<b>PC24L-0012</b>		12 / 3	100*	SJO	115	25	64	<b>EZ-PC24L-0012</b>	<b>4</b>	
<b>PC17L-5010††</b>		10 / 3	-	-	115	35	49	-	<b>2</b>	

### PC SERIES REEL SPECIFICATIONS

#### SLIP RING

- External heavy gauge CPC™ powder coated steel components cover for simple slip ring routine maintenance
- Electrical current runs through a 25AMP / 600V rated slip ring (35AMP on select models)
- Include 5' lead cable & grounding plug (except on less cord models)

#### DESIGN & STRUCTURE

- Single pedestal cord reel with space saving design facilitates workplace organization
- Guide arm adjusts to wall, floor & overhead positions
- Solid one piece, heavy gauge 1/4" steel base & support post for maximum stability
- Coxreels' exclusive Super Hub™ dual axle support system on models with size index #4
- 1" solid steel axle & lubricated precision bearings for smooth rotation
- Controlled retraction speed up to 80% slower on EZ-COIL models
- Enclosed factory tuned & matched cartridge-style spring motor
- Non-corrosive stainless steel spring, pawl & zinc plated ratchet
- Multi-position lock ratchet mechanism secures cord at desired length
- See page 14 for electrical accessories

### REEL DIMENSIONS

Technical Data Sheets Available On Website

SIZE INDEX	W	H	L	X	Y	M	N
<b>1</b>	8 1/2"	14 7/8"	13 1/2"	5"	6"	3"	5"
<b>2</b>	11"	18 5/8"	17"	6"	6"	4"	5"
<b>3</b>	10 1/8"	21"	19 1/2"	6"	6"	4"	5"
<b>4</b>	10 1/4"	25 1/2"	24"	6"	6"	4"	5"

Overall Dimensions      Base      Mounting Pattern

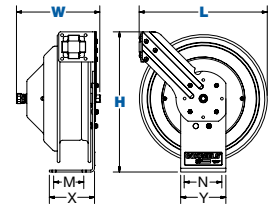

### TOP REQUESTED UPGRADES & ACCESSORIES

SEE PAGE 10 FOR ADDITIONAL ACCESSORIES



#### ORDER EZ-COIL® MODELS

EZ-Coil® is a patented controlled retraction technology offered exclusively on Coxreels' Safety Series reels. It retracts up to 80% slower than conventional reels, resulting in workplace safety, protection from injury & costly property damage.



#### UPGRADE TO SOLID ROLLERS

Heavy duty machined from solid plastic rollers.

#### UPGRADE YOUR LEAD CABLE

Upgrade the reach of your reel by requesting a 10' lead cable instead of the standard 5'.





**!** WARNING: Cancer and reproductive Harm – See page 11 for more information – [www.P65Warning.ca.gov](http://www.P65Warning.ca.gov)



**COXREELS®** PC Series spring driven "Power Cord" reels are heavy duty, industrial grade power sources. They replace tangled extension cords and self-retract to increase safety, productivity and efficiency. Modeled after the P and SH Series, the PC Series are designed for long-lasting, trouble-free performance even under the most demanding conditions.

## PC SERIES

MODEL	ACCESSORY	CORD						EZ-COIL MODELS	SIZE INDEX
		AWG / NO COND.	CORD FT.	TYPE	VOLTS	AMPS	APRX. LBS.		
<b>FOR INDOOR USE ONLY!</b> All models rated at 115 volts, 60 hz single phase only.									
PC13-3516-C†	Fluorescent Tube Light - Shock Absorbing & Shatter Resistant†	16 / 3	35	SJTO	115	0.3	35	-	1
PC13-5016-C†		16 / 3	50	SJTO	115	0.3	37	EZ-PC13-5016-C	1
PC24-0016-C		16 / 3	100	SJTO	115	0.3	75	EZ-PC24-0016-C	3
PC13-3516-D†	Fluorescent Angle Light with Tool Tap Plug†	16 / 3	35	SJTO	115	13	35	-	1
PC13-5016-D†		16 / 3	50	SJTO	115	13	37	EZ-PC13-5016-D	1
PC24-0016-D		16 / 3	100	SJTO	115	13	73	EZ-PC24-0016-D	3
PC13-3516-E†	Incandescent Caged Drop Light with Tool Tap Plug†	16 / 3	35	SJTO	115	13	34	-	1
PC13-5016-E†		16 / 3	50	SJTO	115	13	36	EZ-PC13-5016-E	1
PC19-7516-E		16 / 3	75	SJTO	115	13	60	-	2
PC24-0016-E		16 / 3	100	SJTO	115	13	73	EZ-PC24-0016-E	3
PC-13-5016-H†	Industrial Duty LED Light	16 / 3	50	SJTO	115	.17	37	EZ-PC13-5016-H	1
PC-13-5016-K	Super-Bright LED Light with Tool Tap on Handle	16 / 3	50	SJTO	115	.17	37	EZ-PC13-5016-K	1
PC-13-5016-M	Compact Super-Bright LED Light	16 / 3	50	SJTO	115	.17	37	EZ-PC13-5016-M	1

\*Consult factory with 4 conductor requirements. \*\*When not using specified cord type capacity may vary.

### REEL DIMENSIONS

Technical Data Sheets Available On Website

SIZE INDEX	W	H	L	X	Y	M	N
1	8½"	14⅞"	13½"	5"	6"	3"	5"
2	10⅞"	21"	19½"	6"	6"	4"	5"
3	10¼"	25½"	24"	6"	6"	4"	5"

Overall Dimensions      Base      Mounting Pattern

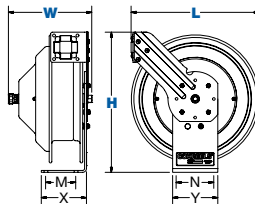

UL Listed †  
NEMA Listed ††  
**SLIP RING**

### PC SERIES - REEL SPECIFICATIONS

- External heavy gauge CPC™ powder coated steel components cover for simple slip ring routine maintenance
- Electrical current runs through a 25AMP / 600V rated slip ring (35AMP on select models)
- Include 5' lead cable & grounding plug (except on less cord models)

### DESIGN & STRUCTURE

- Single pedestal cord reel with space saving design facilitates workplace organization
- Guide arm adjusts to wall, floor & overhead positions
- Solid one piece, heavy gauge ¼" steel base & support post for maximum stability
- Coxreels' exclusive Super Hub™ dual axle support system on models with size index #4
- 1" solid steel axle & lubricated precision bearings for smooth rotation
- Controlled retraction speed up to 80% slower on EZ-COIL models
- Enclosed factory tuned & matched cartridge-style spring motor
- Non-corrosive stainless steel spring, pawl & zinc plated ratchet
- Multi-position lock ratchet mechanism secures cord at desired length
- See page 14 for electrical accessories

SPRING DRIVEN

EZ-COIL®

### TOP REQUESTED UPGRADES & ACCESSORIES

SEE PAGE 10 FOR ADDITIONAL ACCESSORIES



#### ORDER EZ-COIL® MODELS

EZ-Coil® is a patented controlled retraction technology offered exclusively on Coxreels' Safety Series reels. It retracts up to 80% slower than conventional reels, resulting in workplace safety, protection from injury & costly property damage.



#### UPGRADE TO SOLID ROLLERS

Heavy duty machined from solid plastic rollers.



#### UPGRADE YOUR LEAD CABLE

Upgrade the reach of your reel by requesting a 10' lead cable instead of the standard 5'.



WARNING: Cancer and reproductive Harm – See page 11 for more information – www.P65Warning.ca.gov



3/8" I.D.  
12GA - 16GA

# C SERIES

## DUAL PURPOSE HOSE REELS - AIR/ELECTRIC



**COXREELS® C Series "Combination" spring driven air hose/electric cord reels are two reels in one compact assembly.** They are perfect for applications that require pneumatic air and an electrical power feed. The single expanded mounting base creates stability and adds to the convenience of one mounting pattern. This series is also available in dual hose combinations.

### C SERIES

Do not exceed listed hose O.D. to obtain maximum length.

MODEL	ACCESSORY	HOSE & CORD									SIZE INDEX
		AWG / NO COND.	CORD FT.	TYPE	AMPS.	I.D.	O.D.	FT.	PSI	APRX. LBS.	
<b>FOR INDOOR USE ONLY!</b>											
Coxreels electric and pneumatic hose reels operate as two independent, self-retracting 50 foot trouble-free assemblies. All Models rated: 115 volts, 3 conductors, 60hz single phase.											
C-L350-5016-A	Single Industrial Receptacle*	16 / 3	50	SJO	13	3/8"	5/8"	50	300	79	1
C-L350-5012-A		12 / 3	50	SJO	20	3/8"	5/8"	50	300	84	1
C-L350-5012-B	Quad "4 Plug" Industrial Receptacle*	12 / 3	50	SJO	20	3/8"	5/8"	50	300	85	1
C-L350-5016-C	Fluorescent Tube Light - Shock Absorbing & Shatter Resistant*	16 / 3	50	SJTO	0.3	3/8"	5/8"	50	300	79	1
C-L350-5016-D	Fluorescent Angle Light with Tool Tap Plug*	16 / 3	50	SJTO	13	3/8"	5/8"	50	300	79	1
C-L350-5016-E	Incandescent Caged Drop Light with Tool Tap Plug*	16 / 3	50	SJTO	13	3/8"	5/8"	50	300	79	1
C-L350-5016-F	Duplex G.F.C.I. Metal Industrial Receptacle*	16 / 3	50	SJO	13	3/8"	5/8"	50	300	79	1
C-L350-5012-F		12 / 3	50	SJO	20	3/8"	5/8"	50	300	84	1
C-L350-5016-X	With Hose, With Cord, Less Accessory	16 / 3	50	SJO	13	3/8"	5/8"	50	300	78	1
C-L350-5012-X		12 / 3	50	SJO	20	3/8"	5/8"	50	300	83	1
C-L350L-5016L-X	Less Hose, Less Cord, Less Accessory	16 / 3	50	N/A	25	3/8"	5/8"	50	300	71	1
C-L350L-5012L-X		12 / 3	50	N/A	25	3/8"	5/8"	50	300	71	1

### C SERIES :: REEL SPECIFICATIONS

UL Listed\* :: Accessories only

#### SWIVEL & LEAD CABLE

- External fluid path with machined from solid brass 90° full-flow NPT swivel inlet
- Swivel Seals: NITRILE
- External CPC™ powder coated steel components cover for simple slip ring routine maintenance
- Include 5' lead cable & grounding plug (except on less cord models)

#### DESIGN & STRUCTURE

- Compact two reel assembly for air/electric applications, each reel operates independently
- Guide arm adjusts to wall, floor & overhead positions
- Single expanded, 1/4" steel mounting base for increased stability & space efficiency
- One mounting pattern allow 1/2 the installation time required to install 2 reels at one station
- 1" solid steel axle & lubricated precision bearings for smooth rotation
- Enclosed factory tuned & matched cartridge-style spring motor
- Non corrosive stainless steel spring, pawl & zinc plated ratchet
- Multi-position lock ratchet mechanism secures hose/cord at desired length
- See page 14 for electrical accessories

### REEL DIMENSIONS

Technical Data Sheets Available On Website

SIZE INDEX	W	H	L	X	Y	M	N
1	16"	185/8"	17"	8"	9"	7"	8"

Overall Dimensions      Base      Mounting Pattern

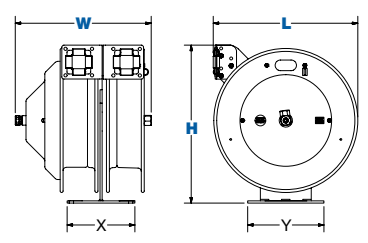

### TOP REQUESTED UPGRADES & ACCESSORIES

SEE PAGE 10 FOR ADDITIONAL ACCESSORIES



#### UPGRADE TO NITRILE OR RUBBER HOSE

**NITRILE HOSE:** Premium high quality, oil resistant, multi-purpose hose. The high tensile spiral synthetic yarn reinforcement provides excellent kink resistance. Temperature range: -20° F to +212° F.

**SYNTHETIC RUBBER HOSE:** Versatile general purpose hose. The synthetic rubber tube and cover resists heat, sunlight, ozone, and weathering. Temperature range -40° F to +212° F.

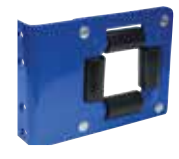

#### UPGRADE TO SOLID ROLLERS

Heavy duty machined from solid plastic rollers.



#### UPGRADE YOUR LEAD CABLE

Upgrade the reach of your reel by requesting a 10' lead cable instead of the standard 5'.

**WARNING:** Cancer and reproductive Harm – See page 11 for more information – [www.P65Warning.ca.gov](http://www.P65Warning.ca.gov)





**COXREELS® 1125PCL Series** professional-grade hand crank and motorized cord reels feature a drum-located, easy to access slip ring assembly for simple routine maintenance and a sturdy all-welded "A" frame built to efficiently handle the most demanding of tasks. The unique permanently lubricated and self-aligning pillow block bearings at each end of the drum allow smooth rotation and are specifically designed for rough, heavy-duty applications. These innovative models handle long length of 12/3 Gage or 10/3 Gage S0 type power cord.

## 1125PC SERIES

- ALL REELS SUPPLIED LESS CORD

LESS CORD						SIZE INDEX
MODEL	12/3 S0	10/3 S0	VOLTS	AMPS	APRX. LBS.	
<b>1125PCL-8-X</b>	250'	200'	600	30	35	<b>1</b>
<b>1125PCL-8M-X</b>	250'	200'	600	45	35	<b>1</b>



### SUFFIX "X" OPTIONS FOR YOUR REEL

Featuring a direct gear drive, the 1125PC Series drive system is more dependable and maintenance free than a chain and sprocket. A solid steel ring gear is directly welded to the side of the disc for added rigidity and strength. Choose from several motor options shown in the table below.

SUFFIX	TYPE	DESCRIPTION	ADD ON LBS
<b>A</b>	AIR - 4 VANE	ALUMINUM BODY AIR MOTOR	8
<b>AB</b>	AIR - 6 VANE	CAST IRON AIR MOTOR	8
<b>C</b>	FRONT HAND CRANK	BEVEL GEARED CRANK	3
<b>E</b>	12 V DC, 1/3 HP	REVERSIBLE	13
<b>ED</b>	12 V DC, 1/2 HP EXP.	EXPLOSION PROOF, REVERSIBLE	26
<b>EF</b>	24 V DC, 1/3 HP	REVERSIBLE	13
<b>EB</b>	24 V DC, 1/2 HP EXP.	EXPLOSION PROOF, REVERSIBLE	26
<b>EA</b>	115 V AC, 1/2 HP EXP.	EXPLOSION PROOF REVERSIBLE AC RECTIFIED	26
<b>EJ</b>	230 V AC, 1/2 HP EXP.	EXPLOSION PROOF REVERSIBLE AC RECTIFIED	26
<b>H</b>	HYDRAULIC	END PORTED 9/16-18 UNF	6

SIZE INDEX	W			H		L	X	Y		Ø	Dw
	CRANK	ELEC.	AIR / HYD.	CRANK	ELEC.			CRANK	ELEC.		
<b>1</b>	21 1/2"	21 5/8"	18 7/8"	18 1/2"	19 1/8"	17 1/2"	13 3/8"	15 1/4"	16"	8 1/2"	8"

Overall Dimensions

Base

Drum

1125PCL Series

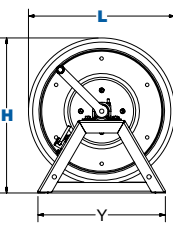
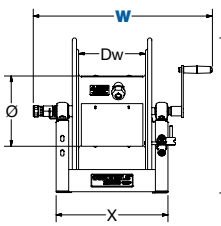

1125PCL Series - Motorized

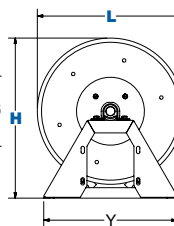
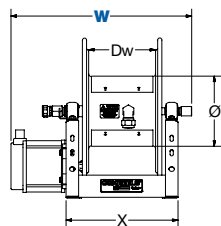

## TOP REQUESTED UPGRADES & ACCESSORIES

SEE PAGE 10 FOR ADDITIONAL ACCESSORIES



### ADD 4-WAY ROLLERS

4-way enclosed pinch-proof stainless steel rollers are 1 in diameter supported by powder coated steel brackets. Weight: Add 10 lbs. to reel weight.



### ADD 3-WAY ROLLERS

3-way open spool roller assembly with 1.5 chrome-plated machined steel spools & 1.5 stainless steel tubing bottom roller & powder coated steel brackets. Weight: Add 14 lbs. to reel weight.

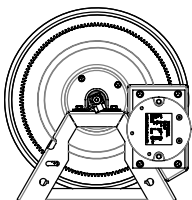

### OFF-SET MOTOR

4-way enclosed pinch-proof stainless steel rollers are 1 in diameter supported by powder coated steel brackets. Weight: Add 10 lbs. to reel weight.



### ADD PINLOCK TO MOTORIZED MODELS

The spring-loaded lock pin assembly is designed to lock & secure the reel, even in mobile conditions over rough terrain.



**WARNING:** Cancer and reproductive Harm – See page 11 for more information – [www.P65Warning.ca.gov](http://www.P65Warning.ca.gov)



3/8" - 1/2" I.D.  
8GA - 16GA

# 112Y SERIES

## COMPACT HAND CRANK HOSE, CORD OR CABLE STORAGE REELS

**COXREELS® 112Y Series** hand crank hose reels are lightweight, compact, versatile reels to store and maintain your hose or cord. Save time and effort while increasing the safety of your work environment. The standard 112Y reels feature a sturdy "U" shaped frame and all steel construction make this one tough little reel. The 112Y-CM reels have a high quality one piece 1" steel tube frame structure.

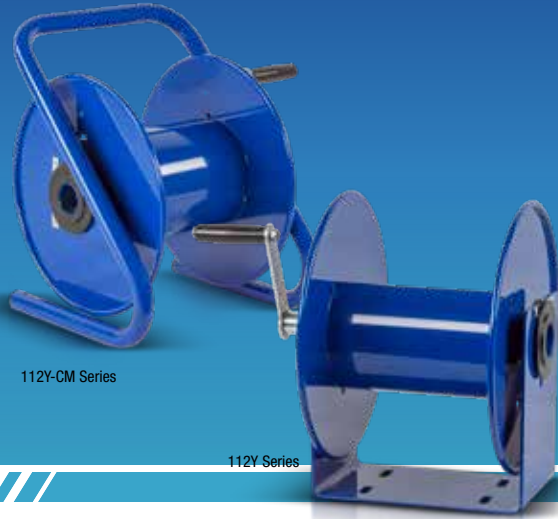

### 112Y SERIES - ALL REELS SUPPLIED LESS HOSE / CORD

MODEL	CABLE I.D.*				HOSE I.D.		APRX. LBS.	SIZE INDEX
	8/3	10/3	12/3	16/3	3/8"	1/2"		
<b>112Y SERIES</b>								
<b>112Y-4</b>	40	75	150	300	50	30	10	<b>1</b>
<b>112Y-8</b>	80	135	300	-	100	55	14	<b>2</b>
<b>112Y-12</b>	150	225	-	-	150	75	20	<b>3</b>
<b>112Y-CM SERIES - CADDY MOUNT</b>								
<b>112Y-8-CM</b>	80	135	300	-	100	55	13	<b>4</b>
<b>112Y-12-CM</b>	150	225	-	-	150	75	19	<b>5</b>

\*Cable length based on SJ cord type

### 112Y SERIES :: REEL SPECIFICATIONS

#### OPEN PORT

- Professional grade, compact & lightweight hand crank reels to store & maintain hose, cord, cable, wire, rope, tape, chain & more.
- Open drum design for no hassle hose wrap
- Open port for easy pass through for any type of hose, cord or cable
- Hose, cord or cable not included.

#### DESIGN & STRUCTURE

- Solid one piece 10GA steel "U" shaped frame
- Base has holes for temporary or permanent installation
- Adjustable tension brake to prevent "free-wheeling" during operation, transport or storage
- Control bar prevents hose, cord or cable from slipping off the discs
- (On 112Y-CM only) High quality one piece 1" steel tube frame structure
- (On 112Y-CM only) "Caddy Mount" offers convenient portability
- Direct hand crank rewind

### REEL DIMENSIONS Technical Data Sheets Available On Website

SIZE INDEX	W	H	L	X	Y	M	N	Ø	Dw
<b>1</b>	12 1/4"	13 1/8"	12"	6"	6"	4"	3"	5 1/2"	4 1/2"
<b>2</b>	15 3/4"	13 1/8"	12"	9 1/2"	6"	5 1/2"	3"	5 1/2"	8"
<b>3</b>	20 1/4"	13 1/8"	12"	14"	6"	10"	3"	5 1/2"	12 1/2"
<b>4</b>	16 3/8"	14 3/4"	13"	11 1/2"	10 5/8"	10 1/2"	5 1/4"	5 1/2"	8"
<b>5</b>	20 7/8"	14 3/4"	13"	16"	10 5/8"	15"	5 1/4"	5 1/2"	12 1/2"

Overall Dimensions Base Mounting Pattern Drum

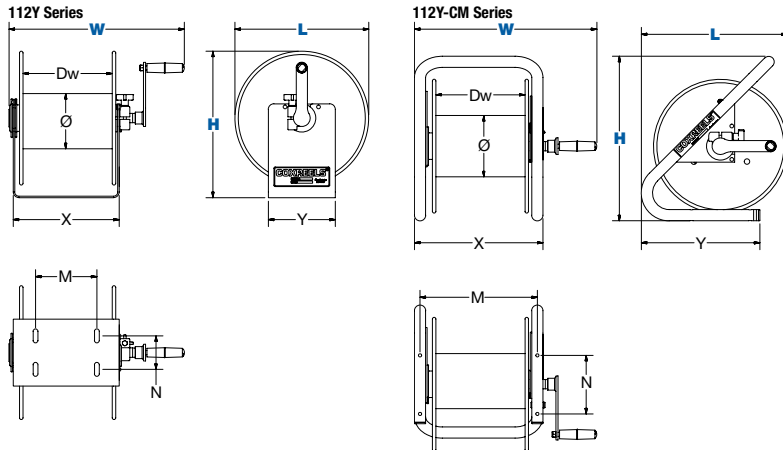

### COXREELS® FEATURE

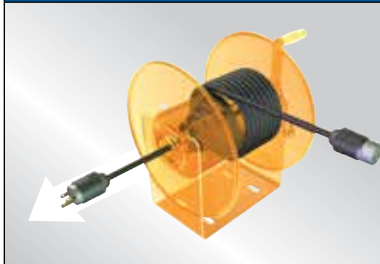

**The access port & open drum allow for quick & easy use of hose cord or cable**







The open drum & access port lets the hose/cord/cable quickly & easily pass thru to the center of the drum where it can be quickly wrapped up for easy storage.

**WARNING:** Cancer and reproductive Harm – See page 11 for more information – [www.P65Warning.ca.gov](http://www.P65Warning.ca.gov)



HAND CRANK

## MOUNTING & ROLLER BRACKETS

PART NO.	SERIES	
	C	PC
 <p><b>Swing Bracket</b> For vertical surface mounting (only stationary installations), allows reel to swing 180°. Powder coated crinkle black 1/4" steel. Weight: 5 lbs.</p>	15720	•
	15725	•
 <p><b>Swivel Bracket</b> For horizontal surface mounting (only stationary installations), ball bearing rotation, allows reel to swivel 345°. Powder coated crinkle black heavy gauge steel. Weight: 6 lbs. NOT FOR USE IN CEILING APPLICATIONS.</p>	15721	• •
	15723	•
 <p><b>EZ-Up Bracket</b> Reel easily slides in &amp; out for easy overhead mounting. Use as an alternative to the #MR-1. Must be ordered with #15724 for "I" or "H" beam installations. Weight: 6.5 lbs.</p>	15723	•
	15724	•
 <p><b>EZ-Up "I" or "H" Beam Adapter</b> Must be ordered with #15723. Powder coated crinkle black, all steel construction. Weight: 5 lbs.</p>	15724	•
	MR-1	•
 <p><b>Mounting Bracket</b> For overhead mounting, fits 3" to 8 1/2" flange on "I" or "H" beam. Powder coated crinkle black 3/16" bent steel. Weight: 13 lbs.</p>	MR-1	•
	MRT-1	•
 <p><b>4-Way Roller Bracket</b> Heavy gauge steel, powder coated Coxreels blue (4RB) Available in stainless steel (4RB-SS). Weight: 1 lbs.</p>	4RB 1/4"-3/4"	• •
	4RB-SS 1/4"-3/4"	• •

## HOSE STOPS & GUARDS

HOSE STOPS PART NO.	HOSE GUARD PART NO.	HOSE		CORD	OVERALL
		I.D.	O.D.		
	131	237-1	1/4"	1/2"	12/3 SJO 2 1/2"
	131-1	237-1	-	-	16/3 SJO 2 1/2"
	131-3	237-1	3/8"	2 1/32"	10/3 SO 2 1/2"

## BEND RESTRICTORS

ADD SUFFIX	I.D.	DESCRIPTION	PSI
-BXB	3/8"	Black PVC Bend Restrictor	300



Designed to limit the degree of bending without compromising the integrity of the hose assembly while also preventing the hose-end from kinking, excessive wearing, & tearing.

## QUICK DISCONNECTS



PART NO.	I.D.	DESCRIPTION	CONNECTION	PSI
10759-2	3/8"	Quick Disconnect	NPT (F)	300

Quick disconnect couplings thread onto end of hose fitting to provide fast, leak-proof connections for low pressure hose lines. Conveniently connect, interchange, & secure pneumatic tools or other spraying devices to any air, water, chemical or other hose lines.



## 4-WAY ROLLER BRACKETS

PART NO.	1125
 <p><b>Top Rewind</b> 4-way enclosed pinch-proof stainless steel rollers are 1" in diameter supported by powder coated steel brackets. Specify drum width. Weight: 10 lbs.</p>	15353*
	•
 <p><b>Bottom Rewind</b> 4-way enclosed pinch-proof stainless steel rollers are 1" in diameter supported by powder coated steel brackets. Specify drum width. Weight: 10 lbs.</p>	15354*
	•
 <p><b>4-Way Roller</b> 4-way enclosed pinch-proof stainless steel rollers are 1" in diameter.</p>	CONSULT FACTORY
	•
<p>*Add drum width dimension as the suffix to the part number EXAMPLE: An 1125-4-200 reel drum width is 12". Order part number: 15353-12</p>	

## 3-WAY ROLLER BRACKET ASSEMBLIES

PART NO.	1125
 <p><b>Top Rewind</b> 3-way open spool roller assembly with 1.5" chrome-plated machined steel spools &amp; 1.5" stainless steel tubing bottom roller and powder coated steel brackets. Specify drum width. Weight: 14 lbs.</p>	15359*
	•
 <p><b>Bottom Rewind</b> 3-way open spool roller assembly with 1.5" chrome-plated machined steel spools &amp; 1.5" stainless steel tubing bottom roller and powder coated steel brackets. Specify drum width. Weight: 14 lbs.</p>	15362*
	•
 <p><b>3-Way Roller</b> 3-way open spool roller assembly with 1.5" chrome-plated machined steel spools &amp; 1.5" stainless steel tubing bottom roller.</p>	CONSULT FACTORY
	•
<p>*Add drum width dimension as the suffix to the part number EXAMPLE: An 1125-4-200 reel drum width is 12". Order part number: 15359-12</p>	

## MODEL UPGRADES & ADDITIONS

PART NO.	1125
 <p><b>Spring Loaded Lock Pin</b> The spring-loaded lock pin assembly is designed to lock &amp; secure the reel, even in mobile conditions over rough terrain.</p>	20843
	•
 <p><b>Gear Guards</b> Guards beveled gears or chain &amp; sprocket from dirt &amp; foreign matter, while also protecting operator from injury.</p>	7406
	•
 <p><b>Heavy Duty Band Brake</b> Steel band lined with brake friction material. Tension is adjusted with a wing nut or a knob by hand (no tools required). - Increased braking power - Increased brake life. - Easier &amp; more precise brake adjustment (control).</p>	8340
	•













WARNING: Cancer and reproductive Harm – See page 11 for more information – www.P65Warning.ca.gov









# ACCESSORIES *HAND CRANK & MOTORIZED REELS*

## SPEED CONTROLLERS FOR MOTORIZED MODELS

	PART NO.	MOTOR OPTIONS							
		E	EB	ED	EA	EF	EJ	A	AB
 <b>Explosion Proof Stationary Push Button Switch</b> For 12V D.C. applications, must be used with solenoid. Cast 3/4" N.P.T. hub inlet.	20882	•							
 <b>Vapor Proof Junction Box</b> Includes box cover & gasket, has three 3/4" N.P.T. hubs.	20883	•	•	•	•	•			
 <b>General Purpose Reversing Switch</b> For direct starting & reversing of A.C. rewind motor.	15210				•				
 <b>Sealed Push Button Switch</b> Weather proof, dust proof momentary contact. To be used with solenoid. 30 AMP.	20876	•	•	•		•			
 <b>Solenoid Relay</b> 12V D.C. for activating motor.	20877	•		•					
 <b>Circuit Breaker</b> 50 amp automatic reset, circuit breaker. A circuit breaker is recommended for all 12V D.C. explosion proof motors.	20878	•		•					
 <b>Switch Box</b> (Includes #20876, #20877, & #20878 & all parts needed to assemble the entire switch box) - Casing is powder coated crinkle black.	8281	•		•					
 <b>Electrical Box &amp; Switch</b> - Installs on any DC electric motor kit. - Push button switch mounts to frame, or to 3-Way Pin Lock. - Works with all guards and accessories.	16780-12 12 VDC	•		•					
	16780-24 24 VDC		•			•			
 <b>115/230 AC/Volt Variable Speed Controller</b> - 10-amp fuse. - On/off push button switch. - Forward/reverse feature.	20875					•			
 <b>115/230 AC/Volt Variable Speed Controller</b> - 10-amp fuse. - On/off push button switch.	20874					•		•	
 <b>115/230 AC/Volt Variable Speed Controller</b> • 10-amp fuse. • Switch not included	20873					•		•	

## SPEED CONTROLLERS FOR MOTORIZED MODELS

	PART NO.	MOTOR OPTIONS							
		E	EB	ED	EA	EF	EJ	A	AB
 <b>12 Volt DC Electric Motor Variable Speed Controller</b> On/off push button switch. • Relay, 50-amp circuit breaker. • Forward/reverse feature.	20872	•		•					
 <b>12 Volt DC Electric Motor Variable Speed Controller</b> On/off push button switch. • Relay, 50-amp circuit breaker.	20871	•		•					
 <b>12 Volt DC Electric Motor Variable Speed Controller</b> • Switch not included	20870	•		•					
 <b>Electric Motor Speed Controller</b> • For AC motors • Fixed speed - 50% less	20868				•				
 <b>Control Valve</b> Control valve for No. 4 Gast Air Motor available upon request	15212								•
 <b>Control Valve</b> Control valve for No. 6 Gast Air Motor available upon request	15212-1								•

## DISTRIBUTORS *MERCHANDISING DISPLAY*

Coxreels Point of Purchase Merchandising Display is a proven "Sales Generator."

It has been tested & proven to increase sales. It's essential in demonstrating the controlled retraction of the EZ-Coil Safety line.

INCLUDES: Heavy-duty powder coated steel display rack, full color product specific hang tags, tri-fold brochures with mountable tri-fold holder & full-color display banner!

- Safe & Simple Demonstration Tool
- Creates Visual Impulse Purchases
- Mix & Match Up To Four Coxreels Models
- Durable Crinkle Black Powder-Coat Finish
- Adjustable Leveling Feet To Prevent Rocking
- Fast & Easy To Assemble
- No Additional Parts Necessary
- Offered Exclusively By Coxreels

Dimensions: 27" W x 58" H x 24" D

Weight: Aprx. 50 lbs

To get a P.O.P. display working for you, call Coxreels Customer Service Department at 1-800-269-7335 and order yours today!



 **WARNING: Cancer and reproductive Harm – See page 11 for more information – www.P65Warning.ca.gov**

# CUSTOMIZE YOUR REEL FROM CONCEPT TO COMPLETION



## CUSTOMIZE YOUR REEL WITH COXREELS CUSTOM PRODUCTS:

Our engineering capabilities and manufacturing processes allow us to design and build top quality products for any conceivable application where reels are needed.

- Customize fluid paths/axles or create custom brackets, mounts, and accessories.
- Integrate with your specific hardware, systems, or devices.
- Modify drums, add divider disks, manipulate openings, or integrate hose handling devices.
- Combine features of various reel model lines, creating your own hybrid reel.
- Create custom retraction systems.
- Increase temperature and pressure capabilities, or multiply fluid paths.
- The possibilities are only limited by your imagination!

### POWDER COAT OPTIONS\*

3 digit suffix for spring driven or 4 digit suffix for hand crank & motorized models.



-BXX or -BXXX  
Blue



-RXX or -RXXX  
Red



-GXX or -GXXX  
Gray



-KXX or -KXXX  
Gloss Black



-CXX or -CXXX  
Crinkle Black

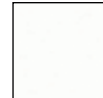

-WXX or -WXXX  
White



-NXX or -NXXX  
Green

\*Minimum quantity & or dollar amount may apply



## EZ-COIL®

### SAFETY REWIND SYSTEM

EZ-Coil® is a patented controlled retraction technology offered exclusively on Coxreels' Safety Series reels. EZ-Coil® retracts up to 80% slower than conventional reels, resulting in workplace safety, protection from injury & costly property damage.

**NOBODY SHOULD BE WITHOUT EZ-COIL®!**

up to **80% Slower Retraction**

	Conventional SPRING DRIVEN REELS	COXREELS' EZ-COIL
<b>SPEED</b>	25 ft./sec.	5 ft./sec.
<b>WHIPPING</b>	5-15 ft.	1 ft.
<b>IMPACT</b>	500 ft./lbs.	0-1 ft./lbs.

Based on an independent evaluation performed by COXREELS. Depending on certain conditions, results may vary.

## ! SAFETY FIRST !

### PLEASE REVIEW ALL SAFETY INFORMATION BEFORE CHOOSING AND USING ALL EQUIPMENT

SERIOUS INJURY, DEATH AND DESTRUCTION OF PROPERTY can result from improper selection or improper use of products described in this catalog. Since COXREELS has no control over the number and variety of applications for which its products may be purchased or the conditions under which they may be used, COXREELS liability on any claim, whether in contract, tort (including negligence), or otherwise, for any loss or damage shall in no case exceed the price paid for product or any part thereof which give rise to claim. However, the general information contained herein shall allow the customer to select and assume all responsibility for product acceptability and fitness for specific applications. As always, COXREELS technical assistance and support is available for your convenience.

NOTE: All designs, specifications, and dimensional data contained in this book are subject to change without notice. No additional warranties, express or implied, including warranties of merchantability for fitness for a particular purpose, are created by the descriptions and depictions of the products on in this book.

### ! PROP 65

In compliance of California's Proposition 65, Coxreels will be applying warning labels to all applicable products with regard to chemicals known to the state of California to cause cancer or reproductive harm.

All reels will carry the following warning.

Parts and components will carry warning labels relative to the respective materials used.

For more information see <http://www.coxreels.com/prop65.html>

#### WARNING

This product can expose you to chemicals including nickel, which are known to the State of California to cause cancer, and chemicals including chromium, which are known to the State of California to cause birth defects or other reproductive harm.

▶ For more information: [www.P65Warnings.ca.gov/product](http://www.P65Warnings.ca.gov/product)



# ELECTRICAL ACCESSORIES



## SINGLE INDUSTRIAL RECEPTACLE

**12/3 AWG**

- Power extension cord features a NEMA 5-20 Female
- Single Receptacle 12 GA
- 3 Conductor SJO black EPDM rubber type wire
- Rated 20 amperages and 115 volts
- Temperature rating – 40 to 194°F



**16/3 AWG**

- Power extension cord features a NEMA 5-15R Female
- Single Receptacle 16 GA
- 3 Conductor SJO black rubber type wire
- Rated 13 amperages and 115 volts
- Temperature rating is 221°F



## QUAD "4 PLUG" INDUSTRIAL RECEPTACLE

**12/3 AWG**

- Portable outlet box with cord strain relief
- Yellow color valox coverplate with duplex receptacle outlet
- 2 duplex receptacle 20 A - 115V Nema 5-20R
- Strain relief cord for convenience



- Smooth face wrap-around galvanized steel traps
- Tamper-resistant shutter complies with national electrical code requirements
- Temperature rating – 40 to 194°F

## DUPLIX G.F.C.I. METAL INDUSTRIAL RECEPTACLE

**12/3 AWG**

- NEMA 5-20 Female
- Duplex Receptacle 12 GA - 115V - 60Hz
- Auto-Ground clip assures a positive ground to metal box
- High-impact-resistant thermoplastic construction.
- Device box has powder coated finins and is provided with aluminum lacquer finish for durability.
- It features dry-tite/weatherproof construction that safeguards wiring devices/switches/electronic components/terminal blocks in dry, damp and wet locations



**16/3 AWG**

- NEMA 5-15R Female
- Duplex Receptacle 16 GA - 115V - 60Hz
- Auto-Ground clip assures a positive ground to metal box
- High-impact-resistant thermoplastic construction.
- Device box has powder coated finins and is provided with aluminum lacquer finish for durability.
- It features dry-tite/weatherproof construction that safeguards wiring devices/switches/electronic components/terminal blocks in dry, damp and wet locations



## FLUORESCENT TUBE LIGHT

**16/3 AWG**

- Patented rough service lamp - 10x more impact resistant!
- Tough polycarbonate outer tube
- Spring steel hook slides up and down the outer tube and rotates for hands free lighting
- Soft end caps provide moisture and dirt resistance and absorb impacts when dropped



- SJTOW oil resistant, watertight cord
- Electrical: 13 Wall, 115 Volt
- Light: Stubby Light Fluorescent
- Cord: 16/2 SJTo Cable with open cord on the other end



## FLUORESCENT ANGLE LIGHT



### 16/3 AWG

- "Angle Light" (fluorescent) with a lamphead ballast and a 15amp receptacle outlet included in lamphead.
- 16GA, SJTO cable with receptacle plug at cord end
- 13 Watt Fluorescent Lamp
- On/Off Switch Built into Handle
- Polycarbonate Lens with 270° Arc of Light
- Shatter-Resistant Housing with Rotating Swivel Hook
- Handle will Accept Magnet #MMC-1
- No Tools Required for Lamp Replacement

## INCANDESCENT CAGED DROP LIGHT



### 16/3 AWG

- Steel Cage Protects the Bulb
- Push-Through On-Off Switch in Handle
- 120VAC, 15 Amp Outlet in handle
- 16GA, SJTO cord with receptacle plug
- Metal grounded swing-open bulb guard with hanging hook
- Max 100 Watt lamp rating
- NEMA 5-15R grounded outlet built in to handle
- No Tools Required for Lamp Replacement

## INDUSTRIAL DUTY LED LIGHT



### 16/3 AWG

- Lite Smoothing Technology™ eliminates shadows and prevents piercing light in user's eyes
- Lensed end LED produces 125 lumens of 5000K colored light
- All LEDs are rated for 50,000 hours
- Ruggedized LED driver in handle is designed to last in commercial and industrial use
- Polycarbonate outer tube is extremely durable
- Twin spring steel hook will not break or bend
- On-off switch in handle cycles between the end light and the side lights
- Impact bumper end ring.

## SUPER-BRIGHT LED LIGHT



### 16/3 AWG

- UV stabilized polycarbonate lens recessed light w/ directional deflector aluminum led frame
- LED Power "ON" Indicator Light
- Folding Swivel Hook and Top Protective Bumper
- 2 Amp grounded Nema 5-15 receptacle switch on back of handle
- Raised soft rubber handle grip
- 1000 Lumens / 6500k Light Color Temp.
- 16/3 SJTO Cord
- Dry location use only

## COMPACT SUPER-BRIGHT LED LIGHT



### 16/3 AWG

- UV stabilized polycarbonate lens recessed light w/ directional deflector aluminum led frame
- LED Power "ON" Indicator Light
- Folding Swivel Hook and rubber bumper end & bottom
- Raised soft rubber handle grip
- Integrated Magnet
- 900 Lumens / 8 Watt cob LED / 6800k light color temp.
- 50,000 hour rating
- 16/3 SJTO Cord
- Dry location use only



## INDUSTRY CATALOGS



## PRODUCT CATALOGS



**CORPORATE HEADQUARTERS:**  
Tempe, Arizona USA  
Phone: 480.820.6396 Fax: 480.820.5132  
Toll Free: 800.COX.REEL Toll Free Fax: 800.229.REEL  
[www.coxreels.com](http://www.coxreels.com) [info@coxreels.com](mailto:info@coxreels.com)

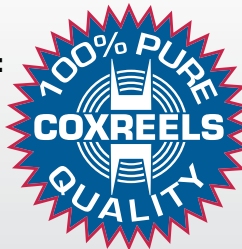

**INTERNATIONAL:**  
EUROPE / MIDDLE EAST / AFRICA  
Phone: +44 (0) 1536 464 990  
Fax: +44 (0) 1536 464 999  
[www.crireels.com](http://www.crireels.com) [sales@cireels.com](mailto:sales@cireels.com)



CATALOG: LT-CELPC20

## ELECTRICAL REELS PRODUCT CATALOG