

HOSE, CORD & CABLE REELS

# Mining

**COXREELS SINCE 1923**

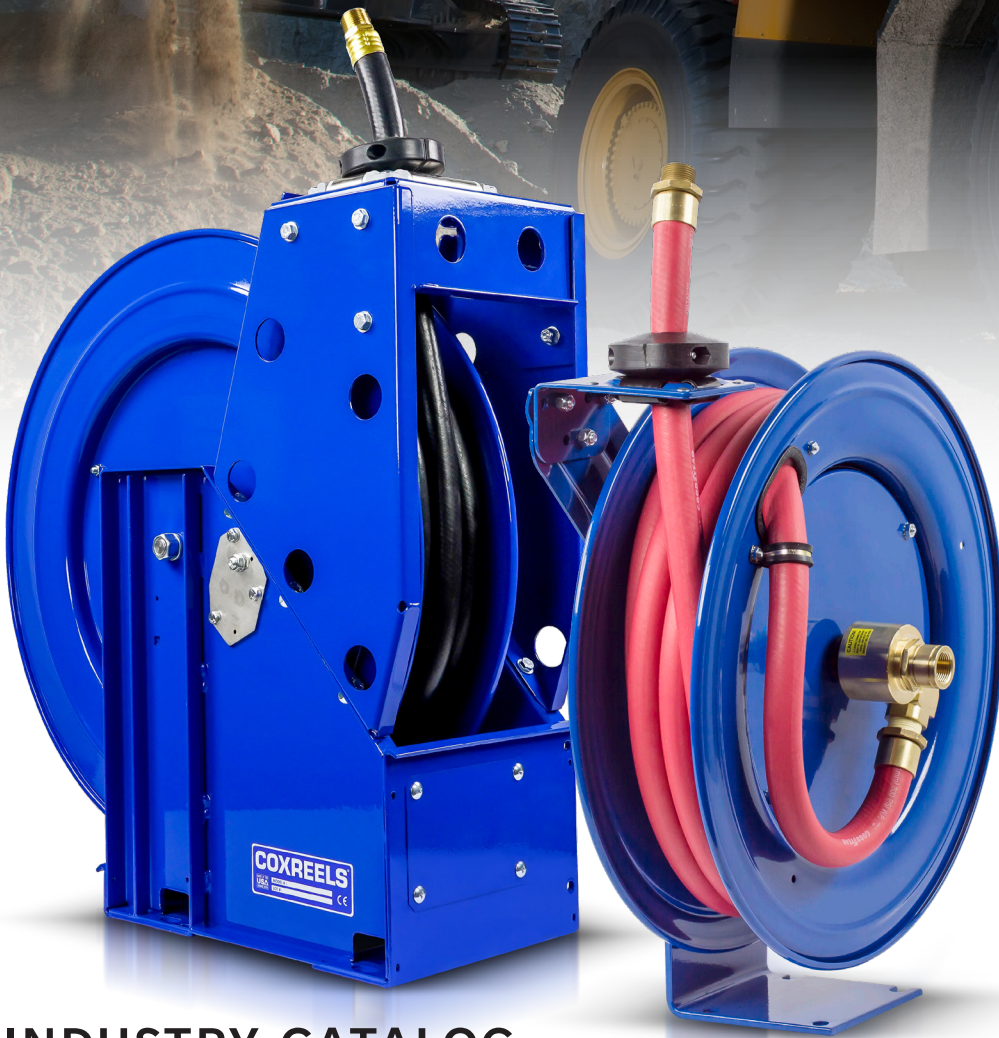

INDUSTRY CATALOG



# MINING REELS



*IT'S NOT JUST A LABEL,*

***IT'S A BADGE OF HONOR***

Hose, cord, and cable reels are essential to tackle the tough work in jobs found in the mining industry. Reels are the preferred choice for managing hoses or neatly and conveniently storing them.

### ***The Recognized Industry Leader***

Coxreels is wholesale only since 1923. Our product is made to high standards, supplying industrial grade product to distributors and OEMs worldwide. We are recognized as the leader in the reeling industry. We have been providing the most complete and diverse line of hose, cord, and cable reels for 10 decades!

### ***The Most Complete Line of Mining Reels in the Market***

Mining workers cannot expect less out of the reels they so heavily rely on. Whether you are mining underground, underwater, or above ground— we got you covered!

Our reels are innovatively designed & built stout right here in the USA to withstand the demanding harsh environments found in the mining area. Let's face it, equipment & reels are exposed to outdoor conditions, chemicals, & take some reasonable abuse in mining applications. To ensure no downtime in your operations, reliability & durability are demanded out of every piece of equipment. COXREELS® renowned quality meets those challenges with flying colors!

### ***Proven reeling solutions to mining needs!***

We have reels for any conceivable application. The common applications we have identified on mining site, trucks, mixers and more include, but are not limited to:

- Pneumatic, hydraulic, and power tools
- Air/Water lines
- High volume fluid delivery
- Paving / sealcoating
- Diesel refuelling
- Fueling & DEF
- Waste oil evacuation
- Welding (Arc / Gas)
- Servicing heavy off-road equipment

Our versatile and wide reel selection handles various capacities and comes in different sizes to suit any construction requirement. Our standard reeling devices suggested in this catalog are already specified to meet the needs of the construction markets. Coxreels also has the engineering power to design and build custom reels, so please consult the factory if you cannot locate a reel that will work with your equipment, we will be happy to assist you with a solution.

***VALUE THE DIFFERENCE...***

***Make COXREELS your reel choice!***



# PROFESSIONAL GRADE FEATURES

## A HIGHER LEVEL OF STANDARDS



**CPC™ POWDER COAT**  
Our blue powder coat finish is long lasting, chip resistant & rust inhibiting



**BRASS SWIVEL**  
External fluid path, machined from solid brass, full flow, swivel for simple seal maintenance

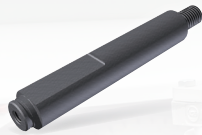

**STEEL AXLE**  
1" solid steel axle & lubricated bearings for extra strength & durability. Not a hollow tube & no fluid travels through it



**STEEL CONSTRUCTION**  
High-Quality steel construction provides superior strength and durability for heavy-duty applications in commercial and industrial settings



**COMPONENT COVER**  
External CPC powder coated steel components cover for simple slip ring routine maintenance



**EZ-COIL® SERIES**  
A patented safety system that retracts up to 80% slower than conventional reels



**CNC SPUN DISCS**  
All steel rolled edges & ribbed discs for added safety, strength & durability

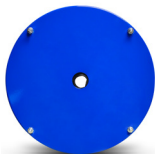

**CARTRIDGE MOTOR**  
Enclosed factory tuned & matched cartridge style motor for safe & easy replacement

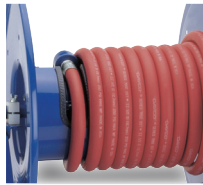

**LOW PROFILE RISER**  
Low profile riser with open drum slot allows for smooth even hose wraps that will not pinch or bind your hose. **NO HUMP!**



**ALL WELDED STEEL "A" FRAME**  
All welded steel "A" frame for strength & durability. **NOT BOLTED!**



**2 YEAR WARRANTY**  
Coxreels proudly stands behind our reels as they are built to last!



**USA MADE, QUALITY & SUPPORT**  
We take great pride in designing, building & supplying the world's finest reels made right here in the U.S.A.

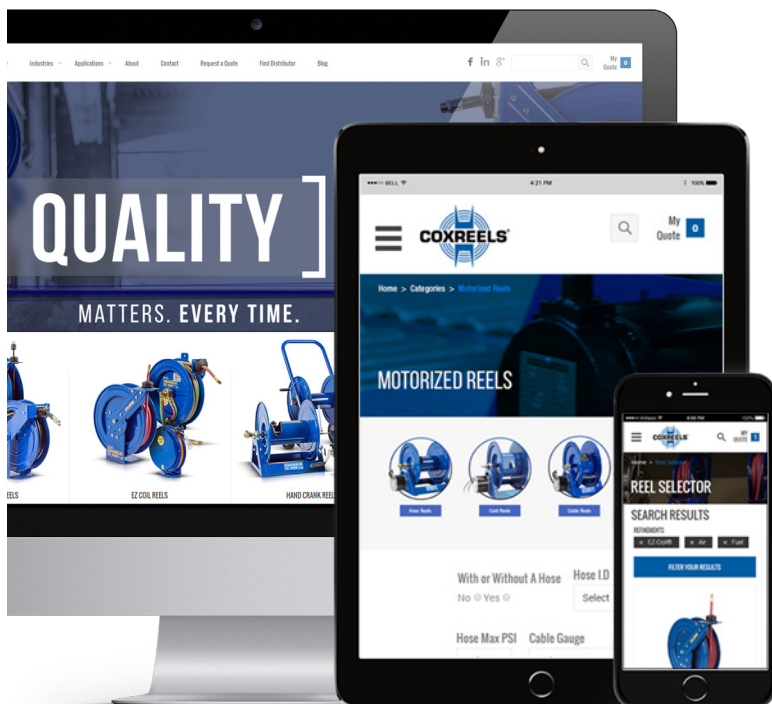

## VISIT US ONLINE

Coxreels is committed to providing our customers with the ultimate online experience as they navigate through the most complete and diverse line of hose, cord, and cable reels.

We hope that you enjoy the fresh look and feel of our updated website and find that this portal serves as a valuable resource for you!

FOLLOW US



www.coxreels.com • 1.800.COX.REEL

MINING 3



# SH, MP & HP SERIES HEAVY DUTY HOSE REELS

1/4" - 3/4" I.D.

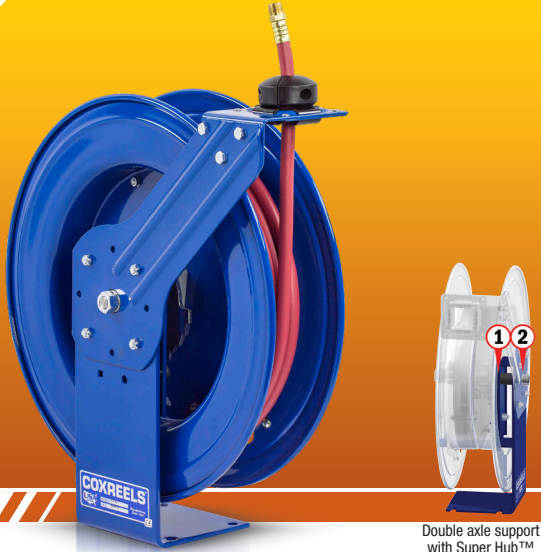

Double axle support with Super Hub™

**COXREELS® SH Series "Super Hub™" spring driven hose reels, like the P Series, have a long history of dependable performance.** The larger chassis and frame accommodate longer lengths and larger diameters of hose. Coxreels' original Super Hub™ dual axle support system increases the stability during operation, reduces vibration and strengthens the structural integrity of the reel.

## SH, MP & HP SERIES

Do not exceed listed hose O.D. to obtain maximum length.

HOSE							LESS HOSE		SIZE INDEX	
MODEL	I.D.	O.D.	FT.	PSI	APPR. LBS.	EZ-COIL MODELS	MODEL	APPR. LBS.		
<b>LOW PRESSURE</b>							Models with hose are for air water service with a maximum temperature 150°F. Models less hose can be used for air, water or oil.			
SH-N-350	3/8"	5/8"	50	300	50	EZ-SH-350	SHL-N-350	44	1	
SH-N-3100	3/8"	5/8"	100	300	71	EZ-SH-3100	SHL-N-3100	60	2	
SH-N-450	1/2"	3/4"	50	300	54	EZ-SH-450	SHL-N-450	46	1	
SH-N-4100	1/2"	3/4"	100	300	81	EZ-SH-4100	SHL-N-4100	66	3	
<b>MEDIUM PRESSURE</b>							Reels are furnished with standard one wire braid hose suitable for air, water or oil applications. Hose exceeds SAE R1 specifications. Maximum Temperature 250°F.			
MP-N-350	3/8"	11/16"	50	3,000	65	EZ-MP-350	MPL-N-350	53	1	
MP-N-450	1/2"	13/16"	50	2,500	67	EZ-MP-450	MPL-N-450	53	4	
<b>HIGH PRESSURE</b>							Reels are furnished standard with S.A.E. 100R16 #1 or #2 wire braid hose suitable for grease and hydraulic oil applications. Maximum Temperature 250°F.			
HP-N-150	1/4"	9/16"	50	5,000	64	EZ-HP-150	HPL-N-150	53	4	
HP-N-350	3/8"	11/16"	50	4,000	65	EZ-HP-350	HPL-N-350	53	5	

### SH, MP & HP SERIES :: REEL SPECIFICATIONS

#### SWIVEL

- External fluid path with machined from solid brass 90° full-flow NPT swivel inlet (Zinc plated steel swivel on HP models)
- Swivel Seals: NITRILE

#### DESIGN & STRUCTURE

- Sturdy single pedestal reel features Coxreels' exclusive Super Hub™ dual axle support system
- Guide arm adjusts to wall, floor, vehicle & overhead positions
- Solid one piece, heavy gauge 1/4" steel base & support post for maximum stability
- 1" solid steel axle & lubricated precision bearings for smooth rotation
- Controlled retraction speed up to 80% slower on EZ-COIL models
- Enclosed factory tuned & matched cartridge-style spring motor
- Non-corrosive stainless steel spring, pawl & zinc plated ratchet
- Multi-position lock ratchet mechanism secures hose at desired length

To order EZ-Coil® equipped models less hose, please add prefix "EZ-"

### REEL DIMENSIONS

SIZE INDEX	W	H	L	X	Y	M	N
1	8 1/4"	21 1/4"	19 1/2"	6"	6"	4"	5"
2	8 1/4"	25 1/2"	24"	6"	6"	4"	5"
3	8 3/4"	25 1/2"	24"	6"	6"	4"	5"
4	8 3/4"	21 1/4"	19 1/2"	6"	6"	4"	5"
5	9 1/4"	21 1/4"	19 1/2"	6"	6"	4"	5"

Overall Dimensions Base Mounting Pattern

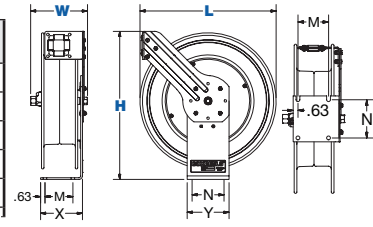

Technical Data Sheets Available On Website

**WARNING:** Cancer and reproductive Harm – See page 15 for more information – [www.P65Warning.ca.gov](http://www.P65Warning.ca.gov)

### TOP REQUESTED UPGRADES & ACCESSORIES

SEE PAGE 13 FOR ADDITIONAL ACCESSORIES



#### ORDER EZ-COIL® MODELS

EZ-Coil® is a patented controlled retraction technology offered exclusively on Coxreels' Safety Series reels. It retracts up to 80% slower than conventional reels, resulting in workplace safety, protection from injury & costly property damage.



#### UPGRADE TO SOLID ROLLERS

Heavy duty machined from solid plastic rollers.

#### UPGRADE TO NITRILE OR RUBBER HOSE

**NITRILE HOSE:** Premium high quality, oil resistant, multi-purpose hose. The high tensile spiral synthetic yarn reinforcement provides excellent kink resistance. Temperature range: -20° F to +212° F.



**SYNTHETIC RUBBER HOSE:** Versatile general purpose hose. The synthetic rubber tube and cover resists heat, sunlight, ozone, and weathering. Temperature range -40° F to +212° F



#### ADD AIR TOOL KIT

**BEND RESTRICTOR:** Designed to limit the degree of bending without compromising the integrity of the hose assembly while also preventing the hose-end from kinking, excessive wearing, and tearing. Available for low pressure models.

**QUICK DISCONNECT:** Quick disconnect couplings tread end of hose fitting to provide fast, leak-proof connections for low pressure hose lines.

#### ADD BEND RESTRICTOR

Designed to limit the degree of bending without compromising the integrity of the hose assembly while also preventing the hose-end from kinking, excessive wearing, and tearing. Available for low pressure models



#### UPGRADE TO STAINLESS STEEL SWIVEL

Based on the upgraded medium pressure swivel, the stainless steel swivel is machined from solid 316 stainless steel and features increased wall thicknesses with upgraded seals and backup rings.





**COXREELS® T Series "Truck Mount" spring driven hose reels are the toughest hose reels in the spring driven line.** The extra large chassis with dual pedestal-style arms and Coxreels' Super Hub™ provides triple axle support while reducing vibration and strengthening the structural integrity of the reel. Making it perfect for on and off-road applications that demand reliability in the most abusive and demanding environments.

## T SERIES

Do not exceed listed hose O.D. to obtain maximum length.

HOSE							LESS HOSE		SIZE INDEX
MODEL	I.D.	O.D.	FT.	PSI	APRX. LBS.	EZ-COIL MODELS	MODEL	APRX. LBS.	
<b>LOW PRESSURE</b>									
Models with hose are for air water service with a maximum temperature 150°F. Models less hose can be used for air, water or oil.									
TSH-N-350	3/8"	5/8"	50	300	61	EZ-TSH-350	TSHL-N-350	55	1
TSH-N-3100	3/8"	5/8"	100	300	85	EZ-TSH-3100	TSHL-N-3100	74	2
TSH-N-450	1/2"	3/4"	50	300	63	EZ-TSH-450	TSHL-N-450	55	1
TSH-N-4100	1/2"	3/4"	100	300	95	EZ-TSH-4100	TSHL-N-4100	80	2
TSH-N-550	3/4"	1 1/16"	50	300	83	EZ-TSH-550	TSHL-N-550	70	3
TSH-N-650	1"	1 1/2"	50	300	98	-	TSHL-N-650	77	4
<b>MEDIUM PRESSURE</b>									
Reels are furnished with standard one wire braid hose suitable for air, water or oil applications. Hose exceeds SAE R1 specifications. Maximum Temperature 250°F.									
TMP-N-350	3/8"	1 1/16"	50	3,000	74	EZ-TMP-350	TMPL-N-350	61	1
TMP-N-375	3/8"	1 1/16"	75	3,000	99	EZ-TMP-375	TMPL-N-375	80	2
TMP-N-3100	3/8"	1 1/16"	100	3,000	106	-	TMPL-N-3100	82	2
TMP-N-450	1/2"	1 3/16"	50	2,500	77	EZ-TMP-450	TMPL-N-450	64	1
TMP-N-475	1/2"	1 3/16"	75	2,500	100	EZ-TMP-475	TMPL-N-475	80	2
TMP-N-4100	1/2"	1 3/16"	100	2,500	106	-	TMPL-N-4100	80	2
TMP-N-550	3/4"	1 1/16"	50	1,500	94	EZ-TMP-550	TMPL-N-550	74	3
TMP-N-575	3/4"	1 1/16"	75	1,500	100	-	TMPL-N-575	77	5
TMP-N-650	1"	1 3/8"	50	1,250	116	-	TMPL-N-650	81	5
<b>HIGH PRESSURE</b>									
Reels are furnished standard with S.A.E. 100R16 #1 or #2 wire braid hose suitable for grease and hydraulic oil applications. Maximum Temperature 250°F.									
THP-N-150	1/4"	9/16"	50	5,000	74	EZ-THP-150	THPL-N-150	62	1
THP-N-175	1/4"	9/16"	75	5,000	88	EZ-THP-175	THPL-N-175	71	2
THP-N-375	3/8"	1 1/16"	75	4,000	98	EZ-THP-375	THPL-N-375	80	2

To order EZ-Coil® equipped models less hose, please add prefix "EZ-"

## REEL DIMENSIONS

SIZE INDEX	W	H	L	X	Y	M	N
1	9 3/8"	21 1/4"	19 1/2"	8"	9"	7"	8"
2	9 3/8"	25 1/2"	24"	8"	9"	7"	8"
3	9 7/8"	25 1/2"	24"	8"	9"	7"	8"
4	12"	25 1/2"	24"	8"	9"	7"	8"
5	12 1/2"	25 1/2"	24"	8"	9"	7"	8"

Overall Dimensions      Base      Mounting Pattern

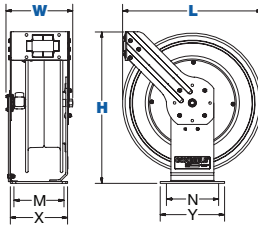

Technical Data Sheets Available On Website

## TOP REQUESTED UPGRADES & ACCESSORIES

SEE PAGE 13 FOR ADDITIONAL ACCESSORIES



### ORDER EZ-COIL® MODELS

EZ-Coil® is a patented controlled retraction technology offered exclusively on Coxreels' Safety Series reels. It retracts up to 80% slower than conventional reels, resulting in workplace safety, protection from injury & costly property damage.

### UPGRADE TO NITRILE OR RUBBER HOSE

**NITRILE HOSE:** Premium high quality, oil resistant, multi-purpose hose. The high tensile spiral synthetic yarn reinforcement provides excellent kink resistance. Temperature range: -20° F to +212° F.

**SYNTHETIC RUBBER HOSE:** Versatile general purpose hose. The synthetic rubber tube and cover resists heat, sunlight, ozone, and weathering. Temperature range -40° F to +212° F

### UPGRADE TO STAINLESS STEEL SWIVEL

Based on the upgraded medium pressure swivel, the stainless steel swivel is machined from solid 316 stainless steel and features increased wall thicknesses with upgraded seals and backup rings.



### UPGRADE TO SOLID ROLLERS

Heavy duty machined from solid plastic rollers. Only for T Series models 3/8" and 1/2".



### ADD AIR TOOL KIT

**BEND RESTRICTOR:** Designed to limit the degree of bending without compromising the integrity of the hose assembly while also preventing the hose-end from kinking, excessive wearing, and tearing. Available for low pressure models.

**QUICK DISCONNECT:** Quick disconnect couplings tread onto end of hose fitting to provide fast, leak-proof connections for low pressure hose lines.

### ADD BEND RESTRICTOR

Designed to limit the degree of bending without compromising the integrity of the hose assembly while also preventing the hose-end from kinking, excessive wearing, and tearing. Available for low pressure models

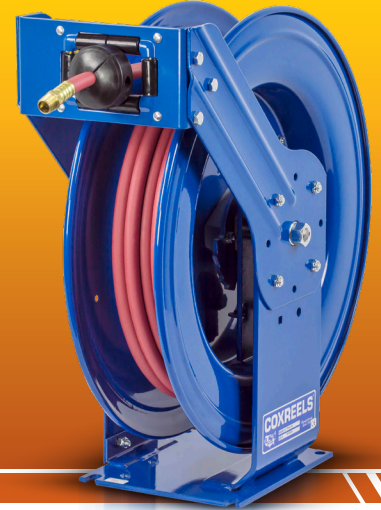

Triple axle support with a full frame & Super Hub™

## T SERIES :: REEL SPECIFICATIONS

### SWIVEL

- External fluid path with machined from solid brass 90° full-flow NPT swivel inlet (Zinc plated steel swivel on HP models)
- Electroless nickel plated steel swivel on 1" models
- Swivel Seals: NITRILE

### DESIGN & STRUCTURE

- Sturdy dual pedestal reel features Coxreels' exclusive Super Hub™ triple axle support system
- Built for rugged mobile applications
- Guide arm adjusts to wall, floor, vehicle & overhead positions
- Stainless Steel rollers on 3/4" & 1" models
- Solid one piece, heavy gauge 1/4" steel base & support posts for maximum strength
- 1" solid steel axle & lubricated precision bearings for smooth rotation
- Controlled retraction speed up to 80% slower on EZ-COIL models
- Enclosed factory tuned & matched cartridge-style spring motor
- Non-corrosive stainless steel spring, pawl & zinc plated ratchet
- Multi-position lock ratchet mechanism secures hose at desired length

WARNING: Cancer and reproductive Harm – See page 15 for more information – www.P65Warning.ca.gov

SPRING DRIVEN

EZ-COIL®



3/8" - 1" I.D.

# EXTREME DUTY SERIES



Bottom Mount

**COXREELS® XTM "Extreme Duty" Series** is designed for high demand industries requiring a level of construction above truck duty. Built with mining, off-road, heavy equipment, and heavy equipment lubrication in mind, the XTM series features the most robust offerings of the reel industry. This series is the combination of all the heavy duty features available inside a solid all-welded box frame, with an integral roller bracket, focused to deliver the toughest reel for the toughest environments and applications.

## XTM SERIES

HOSE						LESS HOSE		SIZE INDEX
MODEL	I.D.	O.D.	FT.	PSI	APRX. LBS.	MODEL	APRX. LBS.	
<b>LOW PRESSURE</b>						Models with hose are for air water service with a maximum temperature 150°F. Models less hose can be used for air, water or oil.		
<b>XTM-LP-375</b>	3/8"	5/8"	75	300	89	-	-	<b>1</b>
<b>XTM-LP-3100</b>	3/8"	5/8"	100	300	92	-	-	<b>1</b>
<b>XTM-LP-475</b>	1/2"	3/4"	75	300	92	-	-	<b>1</b>
<b>XTM-LP-4100</b>	1/2"	3/4"	100	300	96	-	-	<b>1</b>
<b>XTM-LP-550</b>	3/4"	1 1/16"	35	300	94	-	-	<b>1</b>
<b>XTM-LP-575</b>	3/4"	1 1/16"	50	300	101	-	-	<b>2</b>
<b>XTM-LP-650</b>	1"	1 1/2"	50	300	114	<b>XTM-LPL-650</b>	83	<b>2</b>
<b>MEDIUM PRESSURE</b>						Reels are furnished with standard one wire braid hose suitable for air, water or oil applications. Hose exceeds SAE R1 specifications. Maximum Temperature 250°F.		
<b>XTM-MP-350</b>	3/8"	1 1/16"	50	3,000	91	-	-	<b>1</b>
<b>XTM-MP-375</b>	3/8"	1 1/16"	75	3,000	95	-	-	<b>1</b>
<b>XTM-MP-3100</b>	3/8"	1 1/16"	100	3,000	99	<b>XTM-MPL-3100</b>	81	<b>1</b>
<b>XTM-MP-450</b>	1/2"	1 3/16"	50	2,500	93	-	-	<b>1</b>
<b>XTM-MP-475</b>	1/2"	1 3/16"	75	2,500	98	-	-	<b>1</b>
<b>XTM-MP-4100</b>	1/2"	1 3/16"	100	2,500	104	<b>XTM-MPL-4100</b>	81	<b>1</b>
<b>XTM-MP-550</b>	3/4"	1 1/16"	50	1,500	97	<b>XTM-MPL-550</b>	81	<b>1</b>
<b>XTM-MP-575</b>	3/4"	1 1/16"	75	1,500	108	<b>XTM-MPL-575</b>	83	<b>2</b>
<b>XTM-MP-650</b>	1"	1 3/8"	50	1,250	110	<b>XTM-MPL-650</b>	83	<b>2</b>
<b>HIGH PRESSURE</b>						Reels are furnished standard with S.A.E. 100R16 #1 or #2 wire braid hose suitable for grease and hydraulic oil applications. Maximum Temperature 250°F.		
<b>XTM-HP-350</b>	3/8"	1 1/16"	50	4,000	96	-	-	<b>1</b>
<b>XTM-HP-375</b>	3/8"	1 1/16"	75	4,000	103	<b>XTM-HPL-375</b>	81	<b>1</b>

## EXTREME DUTY SERIES :: REEL SPECIFICATIONS

### SWIVEL

- External fluid path with machined from solid brass 90° full-flow NPT swivel inlet & swivel retaining plates (Zinc plated steel swivel on HP models)
- Electroless nickel plated steel swivel on 1" models
- Swivel Seals: NITRILE

### DESIGN & STRUCTURE

- Fully welded box frame construction, with redundant flanges. Wider frames feature Coxreels' exclusive Super Hub™ triple axle support system
- Accessible stainless steel pawl and pawl spring on ratchet locking mechanism
- Stainless Steel rollers on all models
- 1" solid steel axle & dual lubricated precision bearings for smooth & stable rotation
- Enclosed factory tuned & matched cartridge-style spring motor
- Non-corrosive stainless steel spring, pawl & zinc plated ratchet
- Multi-position lock ratchet mechanism secures hose at desired length

**WARNING:** Cancer and reproductive Harm – See page 15 for more information – [www.P65Warning.ca.gov](http://www.P65Warning.ca.gov)

## REEL DIMENSIONS

SIZE INDEX	W	H	L	X	Y	M	N
<b>1</b>	10 1/8"	26 1/8"	24 1/16"	10"	15"	8 29/32"	10"
<b>2</b>	12 3/4"	26 1/8"	24 1/16"	12 3/4"	15"	11 11/16"	10"
<b>FLOOR MOUNT</b>							
<b>1</b>	10 1/16"	26 15/16"	24 5/8"	10"	15"	8 29/32"	10"
<b>2</b>	13 7/16"	26 15/16"	24 5/8"	12 3/4"	15"	11 11/16"	10"
<b>WALL MOUNT</b>							
<b>1</b>	10 1/16"	26 25/32"	24 13/16"	10"	15"	8 29/32"	10"
<b>2</b>	13 7/16"	26 25/32"	24 13/16"	12 3/4"	15"	11 11/16"	10"
Overall Dimensions				Base		Drum	

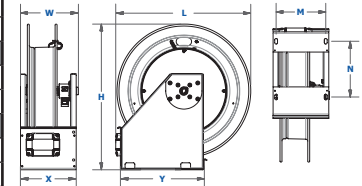

Technical Data Sheets Available On Website

## TOP REQUESTED UPGRADES & ACCESSORIES

SEE PAGE 13 FOR ADDITIONAL ACCESSORIES

### UPGRADE TO NITRILE OR RUBBER HOSE

**NITRILE HOSE:** Premium high quality, oil resistant, multi-purpose hose. The high tensile spiral synthetic yarn reinforcement provides excellent kink resistance. Temperature range: -20° F to +212° F.

**SYNTHETIC RUBBER HOSE:** Versatile general purpose hose. The synthetic rubber tube and cover resists heat, sunlight, ozone, and weathering. Temperature range -40° F to +212° F.

### UPGRADE TO STAINLESS STEEL SWIVEL

Based on the upgraded medium pressure swivel, the stainless steel swivel is machined from solid 316 stainless steel and features increased wall thicknesses with upgraded seals and backup rings.

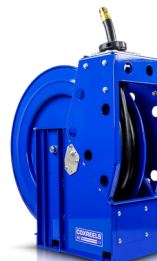

### ADDITIONAL MOUNTING POSITIONS

XTM Reel comes in standard position - Bottom Mount. Available in floor mount and wall mount.

#### Floor Mount

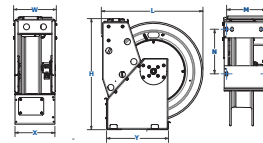

#### Wall Mount

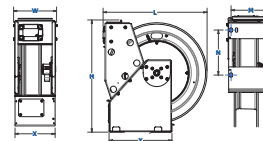



**COXREELS® SP Series "Single Product Delivery" spring driven hose reels are built to handle large hose diameters.** Used in applications demanding large volume delivery in low and medium pressures such as fuel and water. The sturdy box-style frame has heavy duty steel cross supports to all four corners for extra strength and rigidity.



## SP SERIES

Do not exceed listed hose O.D. to obtain maximum length.

HOSE							LESS HOSE		SIZE INDEX
MODEL	I.D.	O.D.	FT.	PSI	INLET/OUTLET N.P.T.	APPRX. LBS.	MODEL	APPRX. LBS.	
<b>LOW PRESSURE</b> Dual braid hose for applications 250 to 300 psi and temperatures to 150° F. Reel less hose 250° F. For higher temperatures and pressures, see price sheet or consult factory.									
SLP-4100	1/2"	3/4"	100	300	1/2"	111	SLPL-4100	96	1
SLP-550	3/4"	1 1/16"	50	300	3/4"	99	SLPL-550	86	2
SLP-575	3/4"	1 1/16"	75	300	3/4"	136	SLPL-575	117	3
SLP-5100	3/4"	1 1/16"	100	300	3/4"	151	SLPL-5100	126	3
SLP-625	1"	1 1/2"	25	300	1"	106	SLPL-625	90	4
SLP-650	1"	1 1/2"	50	300	1"	139	SLPL-650	109	5
SLP-675	1"	1 1/2"	75	300	1"	193	SLPL-675	148	6
Please consult factory for reels with hose	1 1/4"	1 13/16"	25	250	1 1/2"***	-	SLPL-725	110	7
	1 1/4"	1 13/16"	50	250	1 1/2"***	-	SLPL-750	123	8
	1 1/2"	2 1/16"	25	250	1 1/2"	-	SLPL-825	107	7
	1 1/2"	2 1/16"	35	250	1 1/2"	-	SLPL-835	128	8
	1 1/2"	2 1/16"	50	250	1 1/2"	-	SLPL-850	138	9
<b>MEDIUM PRESSURE</b> Steel reinforced 100 RI hose for applications 1500 to 2500 psi and temperatures to 250° F. For higher temperatures and pressures, see price sheet or consult factory.									
SMP-4100	1/2"	1 3/16"	100	2,500	1/2"	139	SMPL-4100	113	1
SMP-550	3/4"	1 1/16"	50	1,500	3/4"	109	SMPL-550	89	2
SMP-575	3/4"	1 1/16"	75	1,500	3/4"	151	SMPL-575	121	3
SMP-5100	3/4"	1 1/16"	100	1,500	3/4"	165	SMPL-5100	126	3
Please consult factory for reels with hose	1"	1 3/8"	25	2,000	1"	-	SMPL-625	92	4
	1"	1 3/8"	50	2,000	1"	-	SMPL-650	110	5
	1"	1 3/8"	75	2,000	1"	-	SMPL-675	135	6

### SP SERIES :: REEL SPECIFICATIONS

#### SWIVEL

- Machined from solid brass 90° full-flow NPT swivel inlets
- Electroless nickel plated steel 90° swivel on 1" models
- External fluid path with in-line electroless nickel plated steel full-flow NPT swivel on 1 1/4" and 1 1/2" models
- Swivel Seals: NITRILE (AFLAS on 1" models)

#### DESIGN & STRUCTURE

- Reel features a sturdy box-style frame design
- Reel adjusts to wall, floor, vehicle & overhead positions
- Heavy gauge 1/4" steel base for maximum strength
- Reinforced steel frame provides maximum strength & stability
- Long lasting self-lubricated flange bearings for smooth rotation
- Heavy duty 1" stainless steel pinch-proof rollers
- Enclosed factory tuned & matched cartridge-style spring motor
- Non corrosive stainless steel pawl spring
- Cast iron lock ring with non-sparking bronze pawl
- Multi-position lock ratchet mechanism secures hose at desired length

WARNING: Cancer and reproductive Harm – See page 15 for more information – [www.P65Warning.ca.gov](http://www.P65Warning.ca.gov)

SPRING DRIVEN

### REEL DIMENSIONS

SIZE INDEX	W	H	L	X	Y	Ø	Dw
1	18 1/2"	20 1/2"	22 7/8"	15 3/8"	21 1/2"	10 1/2"	7 1/2"
2	19 5/8"	20 1/2"	22 7/8"	15 3/8"	21 1/2"	10 1/2"	7 1/2"
3	19 5/8"	24 1/2"	26 3/8"	15 3/8"	25"	10 1/2"	7 1/2"
4	21"	20 1/2"	22 7/8"	15 3/8"	21 1/2"	10 1/2"	7 1/2"
5	21"	24 1/2"	26 3/8"	15 3/8"	25"	10 1/2"	7 1/2"
6	21"	28 1/2"	30 3/8"	15 3/8"	29"	10 1/2"	7 1/2"
7	17 1/2"	24 1/2"	26 3/8"	15 3/8"	25"	10 1/2"	7 1/2"
8	18"	28 1/2"	30 3/8"	15 3/8"	29"	10 1/2"	7 1/2"
9	20"	28 1/2"	30 3/8"	17 3/8"	29"	10 1/2"	9 1/2"

Overall Dimensions      Base      Drum

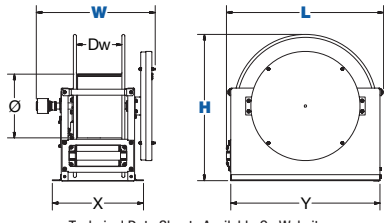

Technical Data Sheets Available On Website

### TOP REQUESTED UPGRADES & ACCESSORIES

SEE PAGE 13 FOR ADDITIONAL ACCESSORIES



#### UPGRADE TO NITRILE OR RUBBER HOSE

**NITRILE HOSE:** Premium high quality, oil resistant, multi-purpose hose. The high tensile spiral synthetic yarn reinforcement provides excellent kink resistance. Temperature range: -20° F to +212° F.

**SYNTHETIC RUBBER HOSE:** Versatile general purpose hose. The synthetic rubber tube and cover resists heat, sunlight, ozone, and weathering. Temperature range -40° F to +212° F

#### UPGRADE TO STAINLESS STEEL SWIVEL

**STAINLESS STEEL CAPTIVE BEARING SWIVEL / STAINLESS STEEL IN-LINE SWIVEL:** the stainless steel swivel is machined from solid 304 stainless steel for increased corrosion resistance. These optional stainless steel swivel are available for 1/4" and 1 1/2" models.

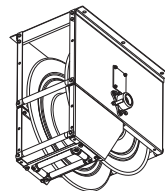

#### ADDITIONAL MOUNTING PATTERNS

**"BXIX":** Ceiling Mount. Use for stretch, recover, or lift.

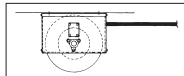

**STRETCH**  
With Or Without Roller Guide  
Special Spring Motor Required,  
Consult Factory

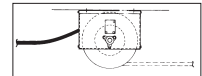

**RECOVER**  
(Pick-up) No Roller Guide Needed,  
Special Spring Motor Required,  
Consult Factory

**"BXCX":** Wall Mount.  
Use for lift.

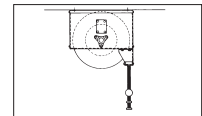

**LIFT**  
With Roller Guide



3/32" Ø

# SD SERIES

## STATIC DISCHARGE CABLE REELS



**COXREELS® SD Series “Static Discharge” cable reels are built heavy duty and designed for long lasting performance.** They are specifically designed to be used in combustible environments where the static buildup could ignite a spark and subsequent explosion. Static discharge or grounding reels are commonly paired with fuel hose reels.

### SD SERIES

CABLE					LESS CABLE		SIZE INDEX
MODEL	FT.	O.D. W/JACKET	APPR. LBS.	<b>EZ-COIL</b> MODELS	MODEL	APPR. LBS.	
<b>GALVANIZED CABLE</b>							
<b>SD-50</b>	50	5/32"	20	<b>EZ-SD-50</b>	<b>SDL-50</b>	18	<b>1</b>
<b>SD-100</b>	100	5/32"	32	<b>EZ-SD-100</b>	<b>SDL-100</b>	28	<b>2</b>
<b>STAINLESS STEEL CABLE</b>							
<b>SD-50-1</b>	50	5/32"	20	<b>EZ-SD-50-1</b>	<b>SDL-50</b>	18	<b>1</b>
<b>SD-100-1</b>	100	5/32"	32	<b>EZ-SD-100-1</b>	<b>SDL-100</b>	28	<b>2</b>

To order **EZ-Coil®** equipped models less cable, please add prefix "EZ-"

### SD & SDH SERIES :: REEL SPECIFICATIONS

#### STATIC DISCHARGE

- Available with 7 strand x 7 wire galvanized steel or stainless steel 5/32" cable
- High visibility orange vinyl cable cover (O.D.= 5/32" with cable cover)
- Includes cable, ball stop & 50 Amp grounding clamp (100 Amp copper grounding clamp available, consult factory)

#### DESIGN & STRUCTURE

- Compact static discharge cable reel available in spring rewind or direct hand crank retraction
- Commonly paired with fuel reels & used in combustible environment for grounding purposes
- Guide arm adjusts to wall, floor, vehicle & overhead positions
- Solid one piece, heavy gauge 1/4" steel base for maximum stability
- 1" solid steel axle & lubricated precision bearings for smooth rotation
- Bottom of base is not powder coated to ground reel
- Controlled retraction speed up to 80% slower on **EZ-COIL** models
- Enclosed factory tuned & matched cartridge-style spring motor
- Non corrosive stainless steel spring, pawl & zinc plated ratchet
- Multi-position non-sparking lock ratchet mechanism secures cable at desired length

### REEL DIMENSIONS

Technical Data Sheets Available On Website

SIZE INDEX	W	H	L	X	Y	N
<b>1</b>	3 7/8"	11 1/2"	11"	2 1/2"	6"	4"
<b>2</b>	4"	15"	14 1/2"	2 1/2"	6"	4"

Overall Dimensions Base Mounting Pattern

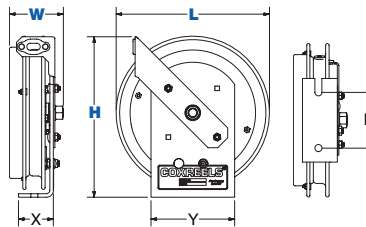

**!** WARNING: Cancer and reproductive Harm – See page 15 for more information – [www.P65Warning.ca.gov](http://www.P65Warning.ca.gov)

### TOP REQUESTED UPGRADES & ACCESSORIES

SEE PAGE 13 FOR ADDITIONAL ACCESSORIES



#### ORDER EZ-COIL® MODELS

EZ-Coil® is a patented controlled retraction technology offered exclusively on Coxreels' Safety Series reels. It retracts up to 80% slower than conventional reels, resulting in workplace safety, protection from injury & costly property damage.



#### ORDER DOUBLE CLAMP

Heavy duty clamps made from zinc plated steel. Both clamps are rated for 50 amp. Each has a jaw opening of 1.06" and a steel spring.

#### ORDER 100 AMP CLAMP

Heavy duty copper clamp designed for heavy grounding requirements. It has a jaw opening of 1.06" and a steel spring.





**COXREELS® DEF Series** are equipped with a stainless steel external full-flow swivel and chemical resistant Viton® seals to provide a safe, reliable Diesel Exhaust Fluid (DEF) dispensing solution. The swivel is easy to access for simple seal maintenance and fast DEF dispenser hose installation. Coxreels® professional DEF reeling systems are available in heavy-duty single pedestal (SH Series) or supreme-duty dual pedestal (T Series) configurations. Both versatile designs are outfitted with Coxreels' original Super Hub™ dual axle support systems to increase stability and reduce vibration during operation, making these reels the perfect DEF handling solutions for either stationary or rugged mobile applications.

DEF T Series

DEF SH Series



**DEF SERIES** Models are equipped with DEF hose. Note: Do not exceed listed hose O.D. to obtain maximum length.

HOSE							LESS HOSE		SIZE INDEX
MODEL	I.D.	O.D.	FT.	PSI	APRX. LBS.	EZ-COIL MODELS	MODEL	APRX. LBS.	
<b>DEF-SH SERIES</b>									
-	1/2"	7/8"	50	300	-	-	*SHL-N-450-BBX	46	1
SH-N-525-DF-BBX	3/4"	1 1/16"	25	300	52	EZ-SH-525-DF-BBX	SHL-N-525-DF-BBX	45	2
SH-N-550-DF-BBX	3/4"	1 1/16"	50	300	69	EZ-SH-550-DF-BBX	SHL-N-550-DF-BBX	56	3
<b>DEF-T SERIES</b>									
-	1/2"	3/4"	50	300	-	-	*TSHL-N-450-BBX	55	4
-	3/4"	1 1/16"	35	300	-	-	*TSHL-N-535-DF-BBX	67	5
TSH-N-550-DF-BBX	3/4"	1 1/16"	50	300	83	EZ-TSH-550-DF-BBX	TSHL-N-550-DF-BBX	70	5
-	1"	1 1/2"	35	300	-	-	TSHL-N-635-BBX	71	6
-	1"	1 1/2"	50	300	-	-	TSHL-N-650-BBX	77	7
<b>DEF-XTM SERIES</b>									
XTM-LP-550-DF-BBX	1"	1 1/2"	50	300	94	-	-	-	8

\*EZ-Coil® option only available on these less hose models. Please add prefix "EZ-"

**REEL DIMENSIONS** Technical Data Sheets Available On Website

SIZE INDEX	W	H	L	X	Y	M	N
1	8 1/4"	21 1/4"	19 1/2"	6"	6"	4"	5"
2	9 3/8"	21 1/4"	19 1/2"	6"	6"	4"	5"
3	9 7/8"	25 1/2"	24"	6"	6"	4"	5"
4	9 3/8"	21 1/4"	19 1/2"	8"	9"	7"	8"
5	9 7/8"	25 1/2"	24"	8"	9"	7"	8"
6	10"	25 1/2"	24"	8"	9"	7"	8"
7	12"	25 1/2"	24"	8"	9"	7"	8"
8	10 1/8"	26 1/8"	24 1/16"	10"	15"	8 29/32"	10"

Overall Dimensions Base Mounting Pattern

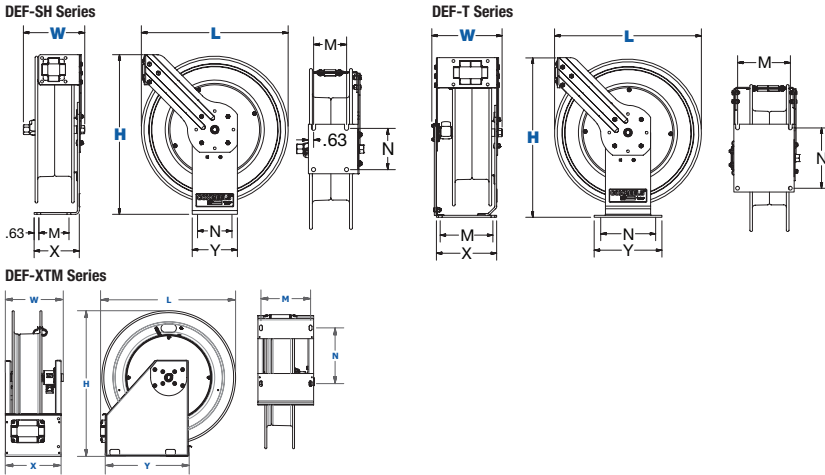

**TOP REQUESTED UPGRADES & ACCESSORIES**

SEE PAGE 13 FOR ADDITIONAL ACCESSORIES



**ORDER EZ-COIL® MODELS**

EZ-Coil® is a patented controlled retraction technology offered exclusively on Coxreels' Safety Series reels. It retracts up to 80% slower than conventional reels, resulting in workplace safety, protection from injury & costly property damage.



**UPGRADE TO SOLID ROLLERS**

Heavy duty machined from solid plastic rollers. Only for T Series 1/2" models and SH Series.

**SWIVEL**

- Non-corrosive stainless steel 90° full flow NPT swivel for Diesel Exhaust Fluid (DEF) dispensing applications.
- Swivel seals: Viton®

**HOSE**

- DEF dispensing hose designed to convey the high-purity, aqueous urea solution DEF.
- Temperature Range: -40°F to +257°F

**DESIGN & STRUCTURE**

- **On SH Models only** - Sturdy single pedestal reel features Coxreels' exclusive Super Hub™ dual axle support system
- **On T Models only** - Sturdy dual pedestal reel features Coxreels' exclusive Super Hub™ triple axle support system. Stainless Steel rollers on 3/4" & 1" models
- **On XTM Models only** Fully welded box frame construction, welded seams & redundant flanges. Wider frames feature Coxreels' exclusive Super Hub™ triple axle support system. Stainless Steel rollers
- **On SH & T Models only** - Guide arm adjusts to wall, floor, vehicle & overhead positions. Solid one piece, heavy gauge 1/4" steel base & support posts for maximum strength. 1" solid steel axle & lubricated precision bearings for smooth rotation
- Enclosed factory tuned & matched cartridge-style spring motor
- Non corrosive stainless steel spring, pawl & zinc plated ratchet
- Multi-position non-sparking lock ratchet mechanism secures cable at desired length

WARNING: Cancer and reproductive Harm – See page 15 for more information – www.P65Warning.ca.gov

SPRING DRIVEN

EZ-COIL®

3/4" - 1" I.D.

# FUEL SERIES

SPRING DRIVEN FUEL HOSE REELS

Fuel T Series

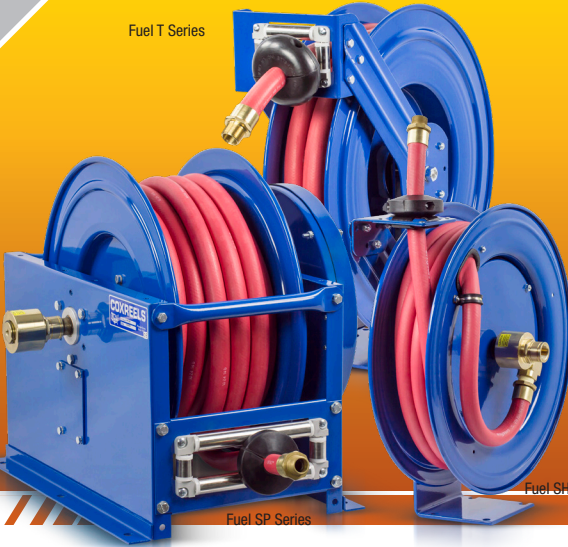

**COXREELS® Fuel Dispensing Reels** are designed to handle various non-aromatic fuel applications including diesel, kerosene, fuel oil and heating oil. Coxreels® professional fuel dispensing reels are available in heavy-duty single pedestal (SH Series), supreme-duty dual pedestal (T Series) or box-style frame (SP Series) configurations. These fuel reels are an essential component found in utility, ground support, and bulk liquid handling transport services mounted on fuel storage & dispensing systems, fuel/lube trucks, aircraft refuelers, and tank trucks. The convenient uncoiling systems with the added hose control allow the operator to efficiently handle fuel transfers.

## FUEL HOSE SERIES

Models are equipped with fuel hose. Note: Do not exceed listed hose O.D. to obtain maximum length.

HOSE							LESS HOSE		SIZE INDEX
MODEL	I.D.	O.D.	FT.	PSI	APRX. LBS.	EZ-COIL MODELS	MODEL	APRX. LBS.	
<b>FUEL HOSE SH SERIES</b>									
SHF-N-525	3/4"	1 3/16"	25	300	52	EZ-SHF-525	*SHFL-N-525	45	1
<b>FUEL HOSE T SERIES</b>									
TSHF-N-535	3/4"	1 3/16"	35	300	77	EZ-TSHF-535	TSHFL-N-535	67	2
TSHF-N-550	3/4"	1 3/16"	50	300	83	EZ-TSHF-550	*TSHFL-N-550	70	2
TSHF-N-575	3/4"	1 3/16"	75	300	93	-	TSHL-N-575-BXN	73	3
TSHF-N-635	1"	1 1/2"	35	300	92	-	TSHL-N-635-BXN	71	4
TSHF-N-650	1"	1 1/2"	50	300	98	-	TSHL-N-650-BXN	77	3
<b>FUEL HOSE XTM SERIES</b>									
XTMF-LP-550	3/4"	1 1/16"	50	300	94	-	-	-	5
XTMF-LP-550-GS	3/4"	1 1/16"	50	300	94	-	-	-	5
XTMF-LP-575	3/4"	1 1/16"	75	300	101	-	-	-	5
XTMF-LP-650	1"	1 1/2"	50	300	114	-	-	-	6
XTMF-LP-650-GS	1"	1 1/2"	50	300	114	-	-	-	6
<b>FUEL HOSE SP SERIES</b>									
SLPF-550	3/4"	1 1/16"	50	300	99	-	SLPL-550	86	7
SLPF-575	3/4"	1 1/16"	75	300	136	-	SLPL-575	117	8
SLPF-5100	3/4"	1 1/16"	100	300	151	-	SLPL-5100	126	8
SLPF-625	1"	1 1/2"	25	300	106	-	SLPL-625	90	9
SLPF-650	1"	1 1/2"	50	300	139	-	SLPL-650	109	10
SLPF-675	1"	1 1/2"	75	300	193	-	SLPL-675	148	11

\* EZ-Coil® option only available on these less hose models. Please add prefix "EZ-"

## FUEL SERIES :: REEL SPECIFICATIONS

### SWIVEL

- Machined from solid brass 90° full-flow NPT swivel inlet for fuel dispensing applications. Electroless nickel plated steel swivel on 1" models
- Swivel seals: Nitrile

### HOSE

- Fuel dispensing hose designed to convey non-aromatic fuels including diesel, kerosene, fuel oil & heating oil. Temperature Range: -20°F to +190°F
- (On -GS Models only) Fuel dispensing hose designed to convey aromatic fuels.

### DESIGN & STRUCTURE

- On SH Models only** - Sturdy single pedestal reel features Coxreels' exclusive Super Hub™ dual axle support system
- On T Models only** - Sturdy dual pedestal reel features Coxreels' exclusive Super Hub™ triple axle support system. Stainless Steel rollers on 3/4" & 1" models
- On XTM Models only** Fully welded box frame construction, welded seams & redundant flanges. Wider frames feature Coxreels' exclusive Super Hub™ triple axle support system. Stainless Steel rollers
- On SP Models only** - Reel features a sturdy box-style frame. Reinforced steel frame provides maximum strength & stability. Heavy duty 1" stainless steel pinch-proof rollers
- On SH & T Models only** - Guide arm adjusts to wall, floor, vehicle & overhead positions. Solid one piece, heavy gauge 1/4" steel base & support posts for maximum strength. 1" solid steel axle & lubricated precision bearings for smooth rotation
- Enclosed factory tuned & matched cartridge-style spring motor
- Non corrosive stainless steel spring, pawl & zinc plated ratchet
- Multi-position non-sparking lock ratchet mechanism secures cable at desired length

**WARNING:** Cancer and reproductive Harm – See page 15 for more information – [www.P65Warning.ca.gov](http://www.P65Warning.ca.gov)

## REEL DIMENSIONS

Technical Data Sheets Available On Website

SIZE INDEX	W	H	L	X	Y	M	N
1	9 3/8"	21 1/4"	19 1/2"	6"	6"	4"	5"
2	9 7/8"	25 1/2"	24"	8"	9"	7"	8"
3	12"	25 1/2"	24"	8"	9"	7"	8"
4	10"	25 1/2"	24"	8"	9"	7"	8"
5	10 1/8"	26 1/8"	24 1/16"	10"	15"	8 29/32"	10"
6	12 3/4"	26 1/8"	24 1/16"	12 3/4"	15"	11 1 1/16"	10"
SIZE INDEX	W	H	L	X	Y	Ø	Dw
7	19 5/8"	20 1/2"	22 7/8"	15 3/8"	21 1/2"	10 1/2"	7 1/2"
8	19 5/8"	24 1/2"	26 3/8"	15 3/8"	25"	10 1/2"	7 1/2"
9	21"	20 1/2"	22 7/8"	15 3/8"	21 1/2"	10 1/2"	7 1/2"
10	21"	24 1/2"	26 3/8"	15 3/8"	25"	10 1/2"	7 1/2"
11	21"	28 1/2"	30 3/8"	15 3/8"	29"	10 1/2"	7 1/2"

Overall Dimensions

Base

Mounting Pattern

## TOP REQUESTED UPGRADES & ACCESSORIES

SEE PAGE 13 FOR ADDITIONAL ACCESSORIES



### ORDER EZ-COIL® MODELS

EZ-Coil® is a patented controlled retraction technology offered exclusively on Coxreels' Safety Series reels. It retracts up to 80% slower than conventional reels, resulting in workplace safety, protection from injury & costly property damage.



### UPGRADE TO SOLID ROLLERS

Heavy duty machined from solid plastic rollers. Only for T Series 1/2" models and SH Series.







1" - 1 1/2" I.D.

# 1600 SERIES

HAND CRANK & MOTORIZED HYBRID FRAME HOSE REELS



1600 Series with optional universal bracket kit, 4-way roller bracket, crank handler holster & bevel gear crank

**COXREELS® 1600 Series features the most versatile symmetric reel design in the market today.** This feature –rich reel series is the most versatile in the marketplace and features nearly endless component configurations on a robust platform for any conceivable application. Targeted for the tough demands of customers requiring various dimensional choices, the series offers flexible size envelopes for any given hose capacity. The 1600 series hybrid frame offers unique accessories and upgrades which allow for application tailoring resulting in enhanced performance and usability.

## 1600 SERIES

- ALL REELS SUPPLIED LESS HOSE

MODEL	Hose Cap. 1" I.D.	Optional Hose Cap. 3/4" I.D.	DIMENSIONS							APRX. LBS	
			DW DRUM WIDTH	L DISC SIZE	W			H	X		Y
					CRANK	ELEC.	AIR/HYD.				
<b>1600 SERIES - 4000 PSI</b>											
1660-0820	50'	60'	8"	20"	23 7/8"	21 5/8"	20 3/8"	21 3/4"	15"	20 1/4"	54
1660-1520	100'	150'	15.5"	20"	31 3/8"	29 1/8"	27 7/8"	21 3/4"	22 1/2"	20 1/4"	68
1660-0924			9.5"	24"	35 3/8"	23 1/8"	21 7/8"	25 1/4"	16 1/2"	23 1/4"	72
1660-2820			28"	20"	43 7/8"	41 5/8"	40 3/8"	21 3/4"	35"	20 1/4"	94
1660-2024	200'	275'	20"	24"	35 7/8"	33 3/8"	32 3/8"	25 1/4"	27"	23 1/4"	91
1660-1128			11.5"	28"	27 3/8"	25 1/8"	23 7/8"	29 1/4"	18 1/2"	26 1/4"	88
1660-2824	300'	450'	28"	24"	43 7/8"	41 5/8"	40 3/8"	25 1/4"	35"	23 1/4"	107
1660-2228	400'	550'	22"	28"	37 7/8"	35 3/8"	34 3/8"	29 1/4"	29"	26 1/4"	112
<b>1600 SERIES - 1500 PSI</b>											
MODEL	Hose Cap. 1 1/2" I.D.	Optional Hose Cap. 1 1/4" I.D.	DW DRUM WIDTH	L DISC SIZE	CRANK	ELEC.	AIR/HYD.	H	X	Y	APRX. LBS
1680-1520			15.5"	20"	28 7/8"	29 1/8"	27 7/8"	21 3/4"	22 1/2"	20 1/4"	68
1680-1124	50'	55'	11.5"	24"	21 3/8"	21 5/8"	20 3/8"	29 1/4"	15"	26 1/4"	73
1680-0828			8"	28"	24 7/8"	25 1/8"	23 7/8"	25 1/4"	18 1/2"	23 1/4"	82
1680-2024	100'	130'	20"	24"	33 3/8"	33 3/8"	32 3/8"	25 1/4"	27"	23 1/4"	91
1680-1328			13.5"	28"	26 7/8"	27 1/8"	25 7/10"	29 1/4"	20 1/2"	26 1/4"	92
1680-3324	200'	200'	33"	24"	46 3/8"	46 5/8"	45 3/8"	25 1/4"	40"	23 1/4"	117
1680-2428			24"	28"	37 3/8"	37 3/8"	36 3/8"	29 1/4"	31"	26 1/4"	114

### 1600 SERIES :: REEL SPECIFICATIONS

#### SWIVEL

- **1660 models** - Nickel plated steel 90° full-flow NPT swivel inlet
- **1680 models** - In-line nickel plated steel full-flow NPT swivel inlet
- Swivel Seals: NITRILE

#### DESIGN & STRUCTURE

- All welded hybrid frame with added bolts
- Exclusive low profile outlet riser & open drum slot design for flat smooth hose wrap
- Permanently lubricated self-aligning pillow block bearings for trouble-free & smooth rotation
- Adjustable tension brake to prevent "free-wheeling" during operation
- **(On hand crank models)** Long-handled locking pin to secure reel from rotation during transport or storage
- Reliable chain & sprocket drive on motor driven models
- Solid steel direct hand crank with smooth round handle
- All metal bevel crank and gear construction



#### MOTORIZED THE REWIND OF YOUR REEL

Featuring a lubricated chain and a zinc plated steel sprocket, the 1600 Series drive system provides a smooth, continuous rewind on motorized reels. Choose from several motor options shown in the table below.

SEE PAGE 22 FOR ADDITIONAL MOTOR ACCESSORIES

SUFFIX	TYPE	DESCRIPTION	ADD ON LBS
A	AIR - 4 VANE	ALUMINUM BODY AIR MOTOR	8
AB	AIR - 6 VANE	CAST IRON AIR MOTOR	8
C	FRONT HAND CRANK	BEVEL GEARED CRANK	3
E	12 V DC, 1/3 HP	REVERSIBLE	13
ED	12 V DC, 1/2 HP EXP.	EXPLOSION PROOF, REVERSIBLE	26
EF	24 V DC, 1/3 HP	REVERSIBLE	13
EB	24 V DC, 1/2 HP EXP.	EXPLOSION PROOF, REVERSIBLE	26
EA	115 V AC, 1/2 HP EXP.	EXPLOSION PROOF REVERSIBLE AC RECTIFIED	26
EJ	230 V AC, 1/2 HP EXP.	EXPLOSION PROOF REVERSIBLE AC RECTIFIED	26
H	HYDRAULIC	END PORTED 3/16-18 UNF	6

**WARNING:** Cancer and reproductive Harm – See page 15 for more information – [www.P65Warning.ca.gov](http://www.P65Warning.ca.gov)

### TOP REQUESTED UPGRADES & ACCESSORIES

SEE PAGE 13 FOR ADDITIONAL ACCESSORIES

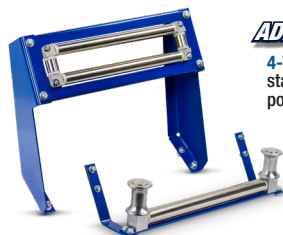

#### ADD ROLLERS

**4-WAY ROLLERS:** 4-way enclosed pinch-proof stainless steel rollers are 1 in diameter supported by powder coated steel brackets.

**3-WAY ROLLERS:** 3-way open spool roller assembly with 1.5 chrome-plated machined steel spools & 1.5 stainless steel tubing bottom roller & powder coated steel brackets.



#### ADD UNIVERSAL ROLLERS

**4-WAY ROLLERS:** 4-way enclosed pinch-proof stainless steel rollers are 1" in diameter.

**3-WAY ROLLERS:** 3-way open spool roller assembly with 1.5" chrome-plated machined steel spools and 1.5" stainless steel bottom roller.

Rollers mounted on universal bracket with 4 various positions 0°, 30°, 60°, 90°. Made from steel, powder coat black.

#### UPGRADE TO STAINLESS STEEL

**STAINLESS STEEL CAPTIVE BEARING SWIVEL:** Featuring heavy duty ball bearings for smooth rotation and increased side load capabilities, the stainless steel swivel is machined from solid 304 stainless steel for increased corrosion resistance.

**STAINLESS STEEL FLUID PATH:** This options uses the same swivel as described in the stainless steel swivel upgrade and couples it to an upgraded 304 stainless steel plumbing axle to improve the corrosion resistance of the entire fluid path.

#### IDLER GEARS AVAILABLE

Reduce drum speed & increase torque. Available in three sizes : 1:2 ratio, 1:3 ratio, and 1:4 ratio, they are factory installed on the motor kits.





## SWIVELS & O-RING COMPATIBILITY CHART

	Brass	Zinc Plated Steel	Electroless Nickel Plated Steel	Stainless Steel	Aluminum	Melonized Steel
<b>Available Swivel I.D.</b> Female NPT fittings (*BSPT fittings available)	1/4"	•	•		•	•
	3/8"	•	•		•	
	1/2"	•	•		•	
	3/4"	•	•		•	
	1"			•	•	
	1 1/2"			•	•	
	2"			•	•	
<b>Available Swivel Seals</b> (Refer to O-Ring Compatibility Chart for desired application)	Buna	•	•	•	•	
	EPDM	•	•	•	•	
	Viton®	•	•	•	•	•
	AFLAS			•	•	

## O-RING COMPATIBILITY CHART

Intended as a general guideline only. Users must test under their own operating guidelines to determine suitability. Please consult factory if your application is not listed.

1 = Recommended | 2 = Fair | 3 = Poor | 4 = Unsatisfactory

	ACETYLENE	AIR (-30°F TO +25°F)	AIR (+25°F TO 200°F)	AIR (200°F TO 300°F)	AIR (300°F TO 400°F)	ANTIFREEZE	FUEL OIL / KEROSENE	GREASE (PETROLEUM BASED)	HYDROCHLORIC ACID	MOTOR OIL (PETROLEUM BASED)	NATURAL GAS	NITROGEN	OXYGEN (200°F TO 300°F)	OXYGEN (COLD)	PESTICIDES	STEAM (BELOW 300°F)	STEAM (300°F TO 400°F)	SEA WATER	WATER (UP TO 200°F)
→	1	1	1	3	4	2	1	1	3	1	1	1	4	2	2	4	4	1	1
→	1	1	1	2	4	1	4	4	2	4	4	1	4	2	4	1	2	1	1
→	1	2	1	1	1	2	1	1	1	1	1	2	1	1	2	3	2	2	2
→	1	3	1	1	1	1	2	2	1	2	1	1	4	2	1	2	3	1	1



**Brass Swivels**

CNC machined from solid brass swivels are built for general multi-purpose applications. Configured in a 90 degree fluid path with full flow designed. Working pressure up to 3000 PSI & -40°F to 400°F\*.



**Zinc Plated Steel Swivels**

Machined from strong low carbon steel and configured in a 90 degree fluid path with full flow designed. Zinc plated steel swivels are recommended for non-corrosive applications. Working pressure up to 5000 PSI & -40°F to 400°F\*.



**Electroless Nickel Plated Steel Swivels**

Machined from strong low carbon steel and configured in a 90 degree fluid path with full flow designed. Nickel plated steel swivels are recommended for mildly corrosive applications. Working pressure up to 4000 PSI & -40°F to 400°F\*.



**Stainless Steel Swivels**

Machined from high quality, pure 316 stainless steel and configured in a 90 degree fluid path with full flow design. Stainless steel swivels offer superior corrosion protection. Working pressure up to 5000 PSI & -40°F to 400°F\*.



**In-line Swivels**

Nickel plated steel or stainless steel swivel configured in an in-line fluid path with full flow design. Working pressure up to 1,500 PSI for 1 1/2" I.D. & 1,000 PSI for 2" I.D. -40°F to 400°F\*.







**Melonized Steel Swivels**

Configured in a 90 degree fluid path with 1/4" ports, melonized steel swivels are used for hydraulic applications. Working pressure up to 10,000 psi & -5°F to 400°F\*.

\*Temperature rating depends on the seal type selected

## MOUNTING & ROLLER BRACKETS

PART NO.	REEL SERIES					
	P	SH, MP & HP	T	PC	P-W & SHW	P-WC
 <b>Swing Bracket</b> For vertical surface mounting, allows reel to swing 180°. Powder coated crinkle black 1/4" steel. Weight: 5 lbs.	<b>15720</b>	•	•	•	•	•
	<b>15725</b>			•		
 <b>Swivel Bracket</b> For horizontal surface mounting, ball bearing rotation, allows reel to swivel 345°. Powder coated crinkle black heavy gauge steel. Weight: 6 lbs. NOT FOR USE IN CEILING APPLICATIONS.	<b>15721</b>	•	•	•	•	•
 <b>EZ-Up Bracket</b> Reel easily slides in & out for easy overhead mounting. Use as an alternative to the #MR-1. Must be ordered with #15724 for "I" or "H" beam installations. Weight: 6.5 lbs.	<b>15723</b>	•	•	•	•	•
 <b>EZ-Up "I" or "H" Beam Adapter</b> Must be ordered with #15723. Powder coated crinkle black, all steel construction. Weight: 5 lbs.	<b>15724</b>	•	•	•	•	•
 <b>Mounting Bracket</b> For overhead mounting, fits 3" to 8 1/2" flange on "I" or "H" beam. Powder coated crinkle black 3/16" bent steel. Weight: 13 lbs.	<b>MR-1</b>	•	•		•	•
	<b>MRT-1</b>			•		
 <b>4-Way Roller Bracket</b> Heavy gauge steel, powder coated Coxreels blue (4RB) Available in stainless steel (4RB-SS). Weight: 1 lbs.	<b>4RB</b> 1/4"-3/4"	•	•	•	•	•
	<b>4RB-SS</b> 1/4"-3/4"	•	•	•	•	•

## HOSE STOPS & GUARDS

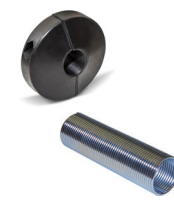

HOSE STOPS PART NO.	HOSE GUARD PART NO.	HOSE		CORD	OVERALL
		I.D.	O.D.		
<b>131</b>	<b>237-1</b>	1/4"	1/2"	12/3 SJO	2 1/2"
<b>131-1</b>	<b>237-1</b>	-	-	16/3 SJO	2 1/2"
<b>131-3</b>	<b>237-1</b>	3/8"	2 1/32"	10/3 SO	2 1/2"
<b>131-4</b>	<b>398-1</b>	1/2"	3/4"	-	2 1/2"
<b>254</b>	-	1/2"	3/4"	-	3 1/2"
<b>430</b>	<b>398-1</b>	3/4"	1"	-	3 1/2"
<b>20214</b>	-	1"	1 9/16"	-	5"

## PVC INLET HOSE ASSEMBLIES



PART NO.	FITTINGS	I.D.	LENGTH	PSI
<b>5150-1.5</b>	1/4" Male x Female NPT	1/4"	18"	300
<b>5153-1.5</b>	3/8" Male x Female NPT	3/8"	18"	300
<b>5154-1.5</b>	1/2" Male x Female NPT	1/2"	18"	300
<b>5155-1.5</b>	3/4" Male x Male NPT	3/4"	18"	300
<b>5224-1.5</b>	3/8" Male x Male NPT	3/8"	18"	3,000
<b>5256-1.5</b>	1/2" Male x Male NPT	1/2"	18"	2,500
<b>5290-1.5</b>	3/4" Male x Male NPT	3/4"	18"	1,500
<b>5304-1.5</b>	1/4" Male x Male NPT	1/4"	18"	5,000
<b>5336-1.5</b>	3/8" Male x Male NPT	3/8"	18"	4,000

## BEND RESTRICTORS



ADD SUFFIX	I.D.	DESCRIPTION	PSI
<b>-BxB</b>	1/4"	Black PVC Bend Restrictor	300
<b>-BxB</b>	3/8"	Black PVC Bend Restrictor	300
<b>-BxB</b>	1/2"	Black PVC Bend Restrictor	300









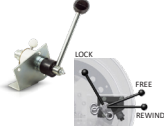

Designed to limit the degree of bending without compromising the integrity of the hose assembly while also preventing the hose-end from kinking, excessive wearing, & tearing.

WARNING: Cancer and reproductive Harm – See page 15 for more information – www.P65Warning.ca.gov





















# ACCESSORIES

## MODEL UPGRADES & ADDITIONS

	PART NO.	AVAILABLE FOR SERIES						
		100	1125	1175	1185	1195	1275	1600
 <p><b>Spring Loaded Lock Pin</b> The spring-loaded lock pin assembly is designed to lock &amp; secure the reel, even in mobile conditions over rough terrain.</p>	<p><b>9077</b></p> <p><b>20843</b></p>	•						
 <p><b>3-Way Pin Lock Kit</b> 3 Positions - Pin locks reel with heavy duty 3/4" solid steel spin. Disengages for free unwind. Can be used to activate switch for electric rewind.</p>	<b>16702</b>						•	
 <p><b>Universal Bracket Kit</b> 4 various positions 0°, 30°, 60°, 90° for mounting bevel crank on either side of the reel. Includes removable center guard cap for easy bearing access. Made from powder coated steel.</p>	<b>16400</b>						•	
 <p><b>Gear Guards</b> Guards beveled gears or chain &amp; sprocket from dirt &amp; foreign matter, while also protecting operator from injury.</p>	<b>7406</b>		•					
	<b>7700</b> 24" disc size			•				
	<b>8176</b>				•			
	<b>8176-1</b> 24" disc size				•			
	<b>8176-2</b> 28" disc size				•			
	<b>16601-122</b> 20" disc size						•	
	<b>16602-138</b> 24" disc size						•	
<b>16602-180</b> 28" disc size						•		
 <p><b>Brawny Reel Upgrade</b> Available for 100 &amp; 1125 Series for 3,000 PSI (BX) or 1125 -5,000 PSI (BH) - 10 gauge plates welded into each disc to keep them from bowing. - Prevents deformation &amp; eventual crushing of the drum that can be caused by hose pressure. - The center drum has been thickened from 16GA to 14GA.</p>	Prefix model <b>BX</b>	•	•					
	Prefix model <b>BH</b>		•					
 <p><b>High Temperature Drag Brake</b> For 1/2" models</p>	<b>7429-1-4</b>		•					
 <p><b>High Temperature Drag Brake</b> For 3/4" models</p>	<b>7429-1-5</b>		•					
 <p><b>3 Way Brake</b> A 3-position brake with lock, friction &amp; free spinning positions. Easily clears brackets &amp; guards for gloved-hand operation. In locked position, does not protrude past front of reel.</p>	<b>16703</b>						•	
 <p><b>Heavy Duty Band Brake</b> Steel band lined with brake friction material. Tension is adjusted with a wing nut or a knob by hand (no tools required). - Increased braking power - Increased brake life. - Easier &amp; more precise brake adjustment (control).</p>	<b>8340</b>		•	•				
	<b>8302</b>				•			
	<b>8302-1</b> 90° Swivel				•			
	<b>16705</b>						•	
 <p><b>Bevel Crank Handle Holster</b> Universal design mounts to either side of the reel with independent mounting holes. Features chained retaining pin to keep handle in place.</p>	<b>16704</b>			•	•	•	•	
 <p><b>Hose Strain Relief Kit</b> - Allows the hose to be secured against the drum. - The clamp provides a strain relief when the hose is fully extended from the reel. - Allow the hose to be routed between the riser connection &amp; the hose clamp with a proper bend radius.</p>	<b>HSRK-050</b> 1/2" Hose		•					
	<b>HSRK-075</b> 3/4" Hose		•	•				
	<b>HSRK-100</b> 1" Hose		•	•			•	
	<b>HSRK-125</b> 1 1/4" Hose				•			
	<b>HSRK-150</b> 1 1/2" Hose				•	•	•	

## SPEED CONTROLLERS FOR MOTORIZED MODELS

	PART NO.	MOTOR OPTIONS							
		E	EB	ED	EA	EF	EJ	A	AB
 <p><b>Explosion Proof Stationary Push Button Switch</b> For 12V D.C. applications, must be used with solenoid. Cast 3/4" N.P.T. hub inlet.</p>	<b>20882</b>	•							
 <p><b>Vapor Proof Junction Box</b> Includes box cover &amp; gasket, has three 3/4" N.P.T. hubs.</p>	<b>20883</b>	•	•	•	•	•			
 <p><b>General Purpose Reversing Switch</b> For direct starting &amp; reversing of A.C. rewind motor.</p>	<b>15210</b>				•				
 <p><b>Sealed Push Button Switch</b> Weather proof, dust proof momentary contact. To be used with solenoid. 30 AMP.</p>	<b>20876</b>	•	•	•		•			
 <p><b>Solenoid Relay</b> 12V D.C. for activating motor.</p>	<b>20877</b>	•		•					
 <p><b>Circuit Breaker</b> 50 amp automatic reset, circuit breaker. A circuit breaker is recommended for all 12V D.C. explosion proof motors.</p>	<b>20878</b>	•		•					
 <p><b>Switch Box</b> (Includes #20876, #20877, &amp; #20878 &amp; all parts needed to assemble the entire switch box) - Casing is powder coated crinkle black.</p>	<b>8281</b>	•		•					
 <p><b>Electrical Box &amp; Switch</b> - Installs on any DC electric motor kit. - Push button switch mounts to frame. or to 3-Way Pin Lock. - Works with all guards and accessories.</p>	<b>16780-12</b> 12 VDC	•		•					
	<b>16780-24</b> 24 VDC		•			•			
 <p><b>115/230 AC/Volt Variable Speed Controller</b> - 10-amp fuse. - On/off push button switch. - Forward/reverse feature.</p>	<b>20875</b>				•				
 <p><b>115/230 AC/Volt Variable Speed Controller</b> - 10-amp fuse. - On/off push button switch.</p>	<b>20874</b>				•		•		
 <p><b>115/230 AC/Volt Variable Speed Controller</b> • 10-amp fuse. • Switch not included</p>	<b>20873</b>				•		•		
 <p><b>12 Volt DC Electric Motor Variable Speed Controller</b> On/off push button switch. • Relay, 50-amp circuit breaker. • Forward/reverse feature.</p>	<b>20872</b>	•		•					
 <p><b>12 Volt DC Electric Motor Variable Speed Controller</b> On/off push button switch. • Relay, 50-amp circuit breaker.</p>	<b>20871</b>	•		•					
 <p><b>12 Volt DC Electric Motor Variable Speed Controller</b> • Switch not included</p>	<b>20870</b>	•		•					
 <p><b>Electric Motor Speed Controller</b> • For AC motors • Fixed speed - 50% less</p>	<b>20868</b>				•				
 <p><b>Control Valve</b> Control valve for No. 4 Gast Air Motor available upon request</p>	<b>15212</b>							•	
 <p><b>Control Valve</b> Control valve for No. 6 Gast Air Motor available upon request</p>	<b>15212-1</b>							•	

 WARNING: Cancer and reproductive Harm – See page 15 for more information – [www.P65Warning.ca.gov](http://www.P65Warning.ca.gov)



# CUSTOMIZE YOUR REEL

FROM CONCEPT TO COMPLETION



## CUSTOMIZE YOUR REEL WITH COXREELS CUSTOM PRODUCTS:

Our engineering capabilities and manufacturing processes allow us to design and build top quality products for any conceivable application where reels are needed.

- Customize fluid paths/axles or create custom brackets, mounts, and accessories.
- Integrate with your specific hardware, systems, or devices.
- Modify drums, add divider disks, manipulate openings, or integrate hose handling devices.
- Combine features of various reel model lines, creating your own hybrid reel.
- Create custom retraction systems.
- Increase temperature and pressure capabilities, or multiply fluid paths.
- The possibilities are only limited by your imagination!

### POWDER COAT OPTIONS\*

3 digit suffix for spring driven or 4 digit suffix for hand crank & motorized models.

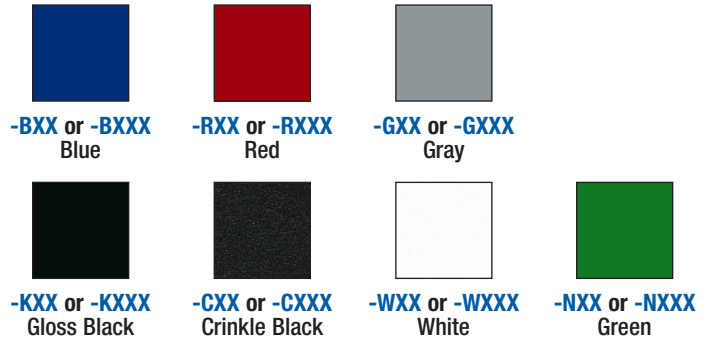

\*Minimum quantity & or dollar amount may apply



# EZ-COIL®

## SAFETY REWIND SYSTEM

EZ-Coil® is a patented controlled retraction technology offered exclusively on Coxreels' Safety Series reels. EZ-Coil® retracts up to 80% slower than conventional reels, resulting in workplace safety, protection from injury & costly property damage.

**NOBODY SHOULD BE WITHOUT EZ-COIL®!**

<b>up to 80% Slower Retraction</b>	Conventional SPRING DRIVEN REELS	COXREELS' EZ-COIL	
	<b>SPEED</b>	25 ft./sec.	5 ft./sec.
	<b>WHIPPING</b>	5-15 ft.	1 ft.
	<b>IMPACT</b>	500 ft./lbs.	0-1 ft./lbs.

Based on an independent evaluation performed by COXREELS. Depending on certain conditions, results may vary.

## ! SAFETY FIRST !

### PLEASE REVIEW ALL SAFETY INFORMATION BEFORE CHOOSING AND USING ALL EQUIPMENT

SERIOUS INJURY, DEATH AND DESTRUCTION OF PROPERTY can result from improper selection or improper use of products described in this catalog. Since COXREELS has no control over the number and variety of applications for which its products may be purchased or the conditions under which they may be used, COXREELS liability on any claim, whether in contract, tort (including negligence), or otherwise, for any loss or damage shall in no case exceed the price paid for product or any part thereof which give rise to claim. However, the general information contained herein shall allow the customer to select and assume all responsibility for product acceptability and fitness for specific applications. As always, COXREELS technical assistance and support is available for your convenience.

**NOTE:** All designs, specifications, and dimensional data contained in this book are subject to change without notice. No additional warranties, express or implied, including warranties of merchantability for fitness for a particular purpose, are created by the descriptions and depictions of the products on in this book.

### ! PROP 65

In compliance of California's Proposition 65, Coxreels will be applying warning labels to all applicable products with regard to chemicals known to the state of California to cause cancer or reproductive harm.

All reels will carry the following warning.

Parts and components will carry warning labels relative to the respective materials used.

For more information see <http://www.coxreels.com/prop65.html>

### WARNING

This product can expose you to chemicals including nickel, which are known to the State of California to cause cancer, and chemicals including chromium, which are known to the State of California to cause birth defects or other reproductive harm.

► For more information: [www.P65Warnings.ca.gov/product](http://www.P65Warnings.ca.gov/product)



[www.coxreels.com](http://www.coxreels.com) • 1.800.COX.REEL

## INDUSTRY CATALOGS



## PRODUCT CATALOGS



100 years  
**Coxreels**  
 USA made since 1923

### CORPORATE HEADQUARTERS:

Tempe, Arizona USA  
 P: 480.820.6396 F: 480.820.5132  
 Toll Free: 800.COX.REEL  
[www.coxreels.com](http://www.coxreels.com) [info@coxreels.com](mailto:info@coxreels.com)

### INTERNATIONAL:

EUROPE / MIDDLE EAST / AFRICA  
 P: +44 (0) 1536 464 990  
 F: +44 (0) 1536 464 999  
[www.crireels.com](http://www.crireels.com) [sales@crireels.com](mailto:sales@crireels.com)

